

目录

1.卡套、螺纹配件

2.直通接头

3.弯通接头

4.三通接头

5.四通接头

卡套、螺纹配件

前后卡套 (双卡套)



卡套螺母



卡套管帽



卡套堵头



螺纹管帽

NPT内螺纹管帽 (P-6)



螺纹堵头

NPT外螺纹堵头 (P-6)



NPT外螺纹内六角堵 (P-6)



G外螺纹堵头 (P-6)



公制外螺纹堵头 (P-6)

SAE/MS外螺纹堵头 (P-6)



SAE/MS外螺纹内六角堵头 (P-6)



直通接头

卡套直通

等径卡套直通 (P-7)



变径卡套直通 (P-7-8)



卡套穿板直通

等径卡套穿板直通 (P-9)



变径卡套穿板直通 (P-9)



卡套-外螺纹直通

英制卡套-NPT外螺纹直通 (P-10)



公制卡套-NPT外螺纹直通 (P-11)

英制卡套穿板-NPT外螺纹直通 (P-12)

公制卡套穿板-NPT外螺纹直通 (P-12)



卡套-NPT外螺纹直通 (O型圈密封) (P-13)



卡套-ISO平行外螺纹直通 (根部复合垫片密封) (P-13-14)



卡套-ISO平行外螺纹直通 (根部金属垫片密封) (P-15-16)



卡套-ISO平行外螺纹直通 (顶部金属垫片密封) (P-17)



卡套-公制外螺纹直通 (顶部金属垫片密封) (P-17-18)



卡套-公制外螺纹直通 (根部复合垫片密封) (P-18-19)



卡套-公制外螺纹直通 (根部O型圈密封) (P-19)



卡套-SAE/MS外螺纹直通 (P-20)



卡套-SAE/MS外螺纹直通 (扣压O型圈密封) (P-21)



卡套-37°扩口外螺纹直通 (P-21)



卡套穿板-37°扩口外螺纹直通 (P-22)



卡套-内螺纹直通

卡套-NPT内螺纹直通
(P-23)



卡套穿板NPT内螺纹直通 (P-24)



卡套-ISO平行内螺纹直通 (底部金属垫片密封) (P-25)



卡套-公制内螺纹直通 (P-26)



钢瓶接头
(P-27)

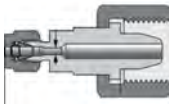

卡套-焊接直通

卡套-仪表管承插焊
(Tube Socket Weld) (P-27)



卡套-公称管对接焊
(Male PipeWeld)
(P-27-28)



卡套管接口直通

卡套-卡套管直通
(P-29)



孔口等径接头
(P-30)



孔口变径接头
(P-30)



NPT外螺纹-卡套管直通 (P-31)



NPT内螺纹-卡套管直通 (P-31)



软管宝塔头接口直通

卡套-软管接口直通 (P-32)



卡套管-软管接口直通 (P-32)

NPT外螺纹-软管接口直通
(P-32)



NPT内螺纹-软管接口直通
(P-32)



软管支撑件
(P-33)



外螺纹直通

NPT外螺纹-NPT外螺纹直通
(P-34)



NPT外螺纹-ISO平行外螺纹直通
(P-34)



NPT外螺纹-SAE/MS平行外螺纹直通 (P-35)



NPT外螺纹-公制外螺纹直通
(P-35)



ISO平行外螺纹-公制外螺纹直通
(P-35)



公制外螺纹-公制外螺纹直通
(P-36)



NPT外螺纹加长直通 (P-36)



外螺纹-内螺纹直通
NPT外螺纹-NPT内螺纹直通 (P-37)



ISO平行外螺纹-NPT内螺纹直通 (根部复合垫片密封) (P-37)



SAE/MS外螺纹-NPT内螺纹直通
(P-38)



NPT外螺纹-ISO平行内螺纹直通
(P-38)



NPT补芯
(P-38)



NPT外螺纹-公制内螺纹活接直通
(P-39)

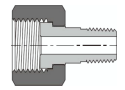

压力表定向接头
(P-39)



内螺纹直通NPT内螺纹直通
(P-40)



ISO锥形内螺纹
(55°) 直通
(P-40)



NPT内螺纹活接直通
(P-40)



焊接直通

卡套管承插焊直通
(Tube SW)
(P-41)



公称管承插焊直通
(Pipe SW)
(P-41)



卡套管承插焊变径直通
(Tube SW)
(P-41)



卡套管对焊变径直通
(Tube BW) (P-42)



NPT外螺纹-卡套管承插焊
(Tube SW) (P-42)



NPT外螺纹-卡套管对接焊
(Tube BW) (P-43)



NPT外螺纹-公称管对接焊
(Pipe BW) (P-43)

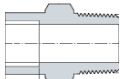

NPT外螺纹-公称管承插焊
(Pipe SW) (P-44)



NPT内螺纹-卡套管对接焊
(Tube SW) (P-44)



NPT内螺纹-卡套管对接焊
(Tube BW) (P-45)

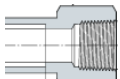

NPT内螺纹-公称管对接焊
(Pipe BW) (P-45)



NPT内螺纹-公称管承插焊
(Pipe SW) (P-45)

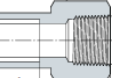

NPT外螺纹-卡套管对接
焊活接头 (Tube BW)
(P-46)



公制内螺纹-卡套管对
接焊活接头 (Tube
BW) (P-46)



弯通接头

卡套弯通

等径卡套弯通
(P-47)



变径卡套弯通
(P-47)



卡套穿板弯通

等径穿板卡套弯通
(P-48)



卡套-外螺纹弯通

卡套-NPT外螺纹弯通
(P-49)



卡套-NPT外螺纹45°
弯通 (P-50)



卡套-SAE/MS外螺纹
可调弯通 (P-50)



卡套-ISO平行外螺纹
可调弯通 (P-51)



卡套-内螺纹弯通

卡套-NPT内螺纹弯通
(P-52)



螺纹弯通

NPT外螺纹弯通
(P-53)



NPT内螺纹弯通
(P-53)



NPT外螺纹-卡套管
承插焊弯通 (Tube
SW) (P-53)



NPT内螺纹-卡套管
承插焊弯通 (Tube
SW) (P-53)



焊接弯通

卡套管承插焊弯通
(Tube SW) (P-54)



卡套管对接焊弯通
(Tube BW) (P-54)



三通接头

卡套三通

等径卡套三通
(P-55)



变径卡套三通
(P-55-56)



卡套-外螺纹三通

支管外螺纹卡套三通
(P-57)



主管外螺纹卡套三通
(P-57)



支管可调SAE/MS外
螺纹卡套三通
(P-58)



主管可调SAE/MS外
螺纹卡套三通
(P-58)



支管可调ISO平行外
螺纹卡套三通
(P-58-59)



主管可调ISO平行外
螺纹卡套三通
(P-59)



卡套-内螺纹三通支管
内螺纹卡套三通
(P-60)



主管内螺纹卡套三通
(P-60)



螺纹三通

NPT外螺纹三通
(P-61)



NPT内螺纹三通
(P-61)



支管NPT内螺纹三通
(P-61)

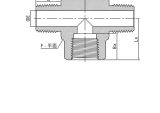

焊接三通

卡套管等径对焊三通
(P-62)



卡套管等径承插焊三
通 (P-62)



四通接头

卡套四通

等径卡套四通 (P-63)



螺纹四通

NPT内螺纹四通
(P-63)



焊接四通

卡套管对焊四通
(P-63)



卡套管承插焊四通
(P-64)



仪表管接头



- 尺寸范围从 1/16" 至 2" 或 2 mm 至 50 mm，多种接口形式可选。
- 弯头通道圆弧连接，确保流体平稳流动。
- 螺母螺纹锁银，可有效减少与本体螺纹的摩擦系数。
- 经硬化和抛光的螺纹延长了接头的寿命，避免内外螺纹的咬合



双卡套

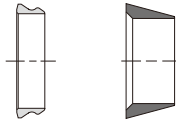

卡套螺母

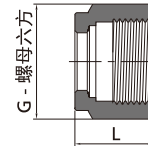

型号	接管外径
	in.
SET1-SS	1/16
SET2-SS	1/8
SET3-SS	3/16
SET4-SS	1/4
SET5-SS	5/16
SET6-SS	3/8
SET8-SS	1/2
SET16-SS	1
SET18-SS	11/8
SET20-SS	11/4
SET24-SS	11/2

型号	接管外径
	mm
SET2M-SS	2
SET3M-SS	3
SET4M-SS	4
SET6M-SS	6
SET8M-SS	8
SET10M-SS	10
SET12M-SS	12
SET18M-SS	18
SET20M-SS	20
SET22M-SS	22
SET25M-SS	25
SET28M-SS	28
SET30M-SS	30
SET32M-SS	32
SET38M-SS	38

型号	接管外径	尺寸mm	
	in.	L	G
N1-SS	1/16	7.9	7.9
N2-SS	1/8	11.9	11.1
N3-SS	3/16	11.9	12.7
N4-SS	1/4	12.7	14.3
N5-SS	5/16	13.5	15.9
N6-SS	3/8	14.2	17.5
N8-SS	1/2	17.5	22.2
N16-SS	1	20.6	38.1
N18-SS	11/8	30.8	44.5
N20-SS	11/4	31.8	47.6
N24-SS	11/2	38.1	57.2

型号	接管外径	尺寸mm	
	mm	L	G
N2M-SS	2	11.9	12
N3M-SS	3	11.9	12
N4M-SS	4	11.9	12
N6M-SS	6	12.7	14
N8M-SS	8	13.5	16
N10M-SS	10	15.1	19
N12M-SS	12	17.4	22
N18M-SS	18	17.4	30
N20M-SS	20	17.4	32
N22M-SS	22	17.4	32
N25M-SS	25	20.6	38
N28M-SS	28	30.6	46
N30M-SS	30	32.7	50
N32M-SS	32	34.4	50
N38M-SS	38	40.6	60

卡套管帽

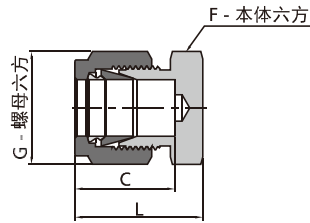

型号	接管尺寸	尺寸 mm			
	in.	L	C	G	F
AC1-SS	1/16	15	8.6	7.9	7.9
AC2-SS	1/8	20.1	12.7	11.1	11.1
AC3-SS	3/16	21.3	13.7	12.7	11.1
AC4-SS	1/4	23.4	15.2	14.3	12.7
AC5-SS	5/16	24.4	16.3	15.9	14.3
AC6-SS	3/8	25.7	16.8	17.5	15.9
AC8-SS	1/2	29.2	22.9	22.2	20.6
AC16-SS	1	38.4	31.2	38.1	34.9
AC18-SS	1 1/8	38.4	36.7	44.5	41.3
AC20-SS	1 1/4	53.3	41.1	47.6	44.5
AC24-SS	1 1/2	64.5	50	57.2	54

型号	接管尺寸	尺寸 mm			
	mm	L	C	G	F
AC2M-SS	2	20.1	12.9	12	12
AC3M-SS	3	20.1	12.9	12	12
AC4M-SS	4	21.3	13.7	12	12
AC6M-SS	6	23.1	15.3	14	14
AC8M-SS	8	24.5	16.2	16	15
AC10M-SS	10	26.6	17.2	19	18
AC12M-SS	12	29.1	22.8	22	22
AC18M-SS	18	31.4	24.4	30	27
AC20M-SS	20	34	26	32	30
AC22M-SS	22	34	26	32	30
AC25M-SS	25	38.5	31.3	38	35
AC28M-SS	28	48.5	36.6	46	41
AC30M-SS	30	53.4	39.6	50	46
AC32M-SS	32	55.8	42	50	46
AC38M-SS	38	65.4	49.4	60	55

卡套堵头

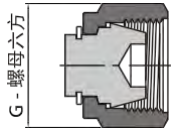

型号	接管外径	尺寸 mm
	in.	G
AP1-SS	1/16	7.9
AP2-SS	1/8	11.1
AP3-SS	3/16	12.7
AP4-SS	1/4	14.3
AP5-SS	5/16	15.9
AP6-SS	3/8	17.5
AP8-SS	1/2	22.2
AP10-SS	5/8	25.4
AP12-SS	3/4	28.6
AP14-SS	7/8	31.8
AP16-SS	1	38.1
AP20-SS	1 1/4	47.6
AP24-SS	1 1/2	57.2

型号	接管外径	尺寸 mm
	mm	G
AP2M-SS	2	12
AP3M-SS	3	12
AP4M-SS	4	12
AP6M-SS	6	14
AP8M-SS	8	16
AP10M-SS	10	19
AP12M-SS	12	22
AP18M-SS	18	30
AP20M-SS	20	32
AP22M-SS	22	32
AP25M-SS	25	38
AP28M-SS	28	46
AP30M-SS	30	50
AP32M-SS	32	50
AP38M-SS	38	60

螺纹管帽

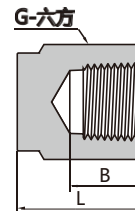

型号	端口类型和尺寸	尺寸, mm		
	NPT, in.	L	F	B
FC1-SS	1/16	12.7	11.1	9.9
FC2-SS	1/8	19.1	14.3	10.4
FC4-SS	1/4	23.1	19.1	15
FC6-SS	3/8	26.2	22.2	15
FC8-SS	1/2	34	27	19.8
FC12-SS	3/4	36.6	33.3	20.6
FC16-SS	1	41.1	41.3	25.4

NPT外螺纹堵头

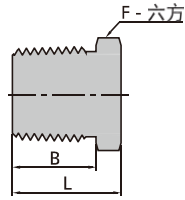

型号	端口类型和尺寸	尺寸mm			
	NPT外, in.	L	F	B	
MP1-SS	1/16	14.2	7.9	9.7	
MP2-SS	1/8	14.2	11.1	9.7	
MP4-SS	1/4	19.1	14.3	14.2	
MP6-SS	3/8	19.8	17.5	14.2	
MP8-SS	1/2	24.6	22.2	19.1	
MP12-SS	3/4	30.7	27	19.1	
MP16-SS	1	38.1	34.9	23.9	
MP20-SS	1 1/4	38.4	44.5	23.9	
MP24-SS	1 1/2	43.7	50.8	26.2	
MP32-SS	2	50.8	69.9	26.2	

NPT外螺纹内六角堵头

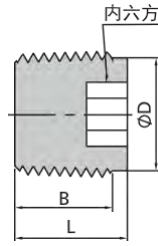

型号	端口类型 好尺寸	尺寸, mm			
	NPT外, in.	L	F	B	D
MP(1)-SS	1/16	7.6	4	7.4	7.4
MP(2)-SS	1/8	10.4	4.8	7.4	9.4
MP(4)-SS	1/4	15.5	6.4	12.4	12.1
MP(6)-SS	3/8	15	7.9	11.9	15.7
MP(8)-SS	1/2	19.3	9.5	16.2	19.3
MP(12)-SS	3/4	19.8	14.3	16.7	25.7
MP(16)-SS	1	20.8	15.9	17.7	31.8

G外螺纹堵头

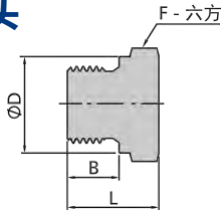

型号	端口类型和尺寸	尺寸mm			
	G外螺纹, in.	L	F	B	D
MPG2-SS	1/8	14	14.3	7.1	13.7
MPG4-SS	1/4	19.8	19.1	11.2	18
MPG6SS	3/8	19.8	22.2	11.2	21.8
MPG8-SS	1/2	25.1	27	14	25.9
MPG12-SS	3/4	28.7	33.3	15.7	32
MPG16-SS	1	30.7	41.3	18	39.1

公制外螺纹堵头

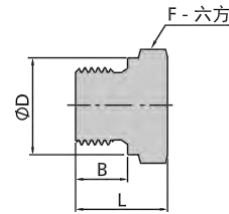

型号	端口类型和尺寸	尺寸 mm		
	公制外螺纹, mm.	L	F	B
MPM14*1.5-SS	M14*1.5	18	16	13
MPM16*1.5-SS	M16*1.5	20	18	14
MPM18*1.5-SS	M18*1.5	22	19	15
MPM20*1.5-SS	M20*1.5	24	22	16
MPM22*1.5-SS	M22*1.5	26	24	17
MPM24*1.5-SS	M24*1.5	26	27	17
MPM27*2-SS	M27*2	27	30	18
MPM30*2-SS	M30*2	32	32	20

SAE/MS外螺纹堵头

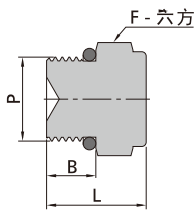

型号	端口类型和尺寸	尺寸, mm		
	SAE/MS外螺纹	L	F	B
MPUNF7-20-SS	7/16-20	19.3	14.3	9.1
MPUNF9-18-SS	9/16-18	20.8	17.5	9.9
MPUNF3/4-16-SS	3/4-16	22.6	22.2	11.2
MPUNF1 1/16-12-SS	1 1/16-12	28.4	31.8	15
MPUNF1 5/16-12-SS	1 5/16-12	30	38.1	15

SAE/MS外螺纹内六角堵头

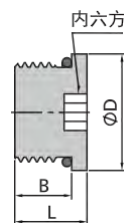

型号	端口类型和尺寸	尺寸, mm			
	SAE/MS外螺纹	L	F	B	D
MP(UNF)7/16-20-SS	7/16-20	11.4	4.8	9.1	14.2
MP(UNF)9/16-18-SS	9/16-18	12.2	6.4	9.9	17.5
MP(UNF)3/4-16-SS	3/4-16	14.2	7.9	11.2	22.4
MP(UNF)1 1/16-12-SS	1 1/16-12	19.1	14.3	15	31.8
MP(UNF)1 5/16-12-SS	1 5/16-12	19.1	15.9	15	38.1

等径卡套直通

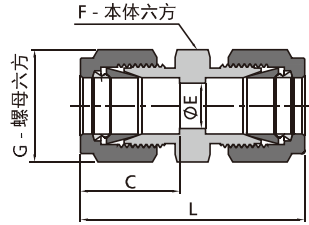

型号	接口尺寸	尺寸mm				
	in.	L	C	G	F	E
A1-U-SS	1/16	25.1	8.6	7.9	7.9	1.3
A2-U-SS	1/8	35.6	12.7	11.1	11.1	2.3
A3-U-SS	3/16	37.3	13.7	12.7	12.7	3
A4-U-SS	1/4	40.9	15.2	14.3	12.7	4.8
A5-U-SS	5/16	42.9	16.2	15.9	14.3	6.4
A6-U-SS	3/8	45	16.8	17.5	15.9	7.1
A8-U-SS	1/2	51.3	22.9	22.2	20.6	10.4
A10-U-SS	5/8	52.1	24.4	25.4	23.9	12.7
A12-U-SS	3/4	53.6	24.4	28.6	27	15.7
A14-U-SS	7/8	55.7	25.9	31.8	30.2	18.3
A16-U-SS	1	64.8	31.2	38.1	34.9	22.4
A18-U-SS	1 1/8	88.2	36.7	44.5	41.3	24.6
A20-U-SS	1 1/4	92.2	41.1	47.6	44.5	27.7
A24-U-SS	1 1/2	108	50	57.2	54	34

型号	接口尺寸	尺寸mm				
	mm	L	C	G	F	E
A2M-U-SS	2	35.6	12.9	12	12	1.7
A3M-U-SS	3	35.3	12.9	12	12	2.4
A4M-U-SS	4	37.3	13.7	12	12	2.4
A6M-U-SS	6	41	15.3	14	14	4.8
A8M-U-SS	8	43.2	16.2	16	15	6.4
A10M-U-SS	10	46.2	17.2	19	18	7.9
A12M-U-SS	12	51.2	22.8	22	22	9.5
A14M-U-SS	14	52	24.4	25	24	11.1
A15M-U-SS	15	52	24.4	25	24	11.9
A16M-U-SS	16	52	24.4	25	24	12.7
A18M-U-SS	18	53.5	24.4	30	27	15.1
A20M-U-SS	20	55	26	32	30	15.9
A22M-U-SS	22	55	26	32	30	18.3
A25M-U-SS	25	65	31.3	38	35	21.8
A28M-U-SS	28	85	36.6	46	41	21.8
A30M-U-SS	30	92.7	39.6	50	46	26.2
A32M-U-SS	32	97.3	42	50	46	28.6
A38M-U-SS	38	113.6	49.4	60	55	33.7

变径卡套直通

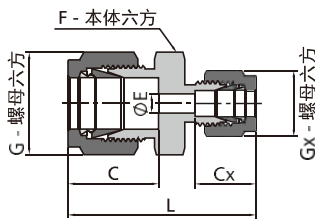

英制转英制

型号	接口尺寸		尺寸 mm						
	端口1	端口2	L	C	G	F	E	CX	GX
A2-A1-U-SS	1/8in.	1/16in.	31	12.7	11.1	11.1	1.3	8.6	7.9
A3-A1-U-SS	3/16in.	1/16in.	32.3	13.7	12.7	11.1	1.3	8.6	7.9
A3-A2-U-SS	3/16in.	1/8in.	36.6	13.7	12.7	11.1	2.3	12.7	11.1
A4-A1-U-SS	1/4in.	1/16in.	34.3	15.2	14.3	12.7	1.3	8.6	7.9
A4-A2-U-SS	1/4in.	1/8in.	38.6	15.2	14.3	12.7	2.3	12.7	11.1
A4-A3-U-SS	1/4in.	3/16in.	39.4	15.2	14.3	12.7	3	13.7	12.7
A5-A2-U-SS	5/16in.	1/8in.	39.6	16.2	15.9	14.3	2.3	12.7	11.1
A5-A4-U-SS	5/16in.	1/4in.	42.2	16.2	15.9	14.3	4.8	15.2	14.3
A6-A1-U-SS	3/8in.	1/16in.	36.6	16.8	17.5	15.9	1.3	8.6	7.9
A6-A2-U-SS	3/8in.	1/8in.	40.9	16.8	17.5	15.9	2.3	12.7	11.1
A6-A4-U-SS	3/8in.	1/4in.	43.2	16.8	17.5	15.9	4.8	15.2	14.3
A6-A5-U-SS	3/8in.	5/16in.	44.2	16.8	17.5	15.9	6.4	16.2	15.9
A8-A2-U-SS	1/2in.	1/8in.	45.2	22.8	22.2	20.6	2.3	12.7	11.1
A8-A4-U-SS	1/2in.	1/4in.	47	22.8	22.2	20.6	4.8	15.2	14.3
A8-A6-U-SS	1/2in.	3/8in.	48.5	22.8	22.2	20.6	7.1	16.8	17.5
A10-A6-U-SS	5/8in.	3/8in.	49.3	24.4	25.4	23.9	7.1	16.8	17.5
A10-A8-U-SS	5/8in.	1/2in.	52.1	24.4	25.4	23.9	10.4	22.8	22.2
A12-A4-U-SS	3/4in.	1/4in.	49.3	24.4	28.6	27	4.8	15.2	14.3
A12-A6-U-SS	3/4in.	3/8in.	50.8	24.4	28.6	27	7.1	16.8	17.5
A12-A8-U-SS	3/4in.	1/2in.	53.6	24.4	28.6	27	10.4	22.8	22.2
A12-A10-U-SS	3/4in.	5/8in.	53.6	24.4	28.6	27	12.7	24.4	25.4
A16-A8-U-SS	1in.	1/2in.	60.5	31.2	38.1	34.9	10.4	22.8	22.2
A16-A12-U-SS	1in.	3/4in.	60.5	31.2	38.1	34.9	15.7	24.4	28.6

公制转公制

型号	接口尺寸		尺寸 mm						
	端口1	端口2	L	C	G	F	E	CX	GX
A3M-A2M-U-SS	3mm	2mm	35.3	12.9	12	12	1.7	12.9	12
A6M-A2M-U-SS	6mm	2mm	38.6	15.3	14	14	1.7	12.9	12
A6M-A3M-U-SS	6mm	3mm	38.6	15.3	14	14	2.4	12.9	12
A6M-A4M-U-SS	6mm	4mm	39.4	15.3	14	14	2.4	13.7	12
A8M-A6M-U-SS	8mm	6mm	42.3	16.3	16	15	4.8	15.3	14
A10M-A6M-U-SS	10mm	6mm	44.5	17.2	19	18	4.8	15.3	14
A10M-A8M-U-SS	10mm	8mm	45.1	17.2	19	18	6.4	16.3	16
A12M-A6M-U-SS	12mm	6mm	47	22.8	22	22	4.8	15.3	14
A12M-A8M-U-SS	12mm	8mm	47.8	22.8	22	22	6.4	16.3	16
A12M-A10M-U-SS	12mm	10mm	48.7	22.8	22	22	7.9	17.2	19
A16M-A10M-U-SS	16mm	10mm	49.5	24.4	25	24	7.9	17.2	19
A16M-A12M-U-SS	16mm	12mm	52	24.4	25	24	9.5	22.8	22
A18M-A12M-U-SS	18mm	12mm	53.5	24.4	30	27	9.5	22.8	22
A25M-A18M-U-SS	25mm	18mm	61	31.3	38	35	15.1	24.4	30
A25M-A20M-U-SS	25mm	20mm	62.3	31.3	38	35	15.9	26	32
A30M-A18M-U-SS	30mm	18mm	75.4	39.6	50	46	15.1	24.4	30
A30M-A20M-U-SS	30mm	20mm	75.4	39.6	50	46	15.9	26	32
A30M-A25M-U-SS	30mm	25mm	80.1	39.6	50	46	21.8	31.3	38
A32M-A18M-U-SS	32mm	18mm	77.8	42	50	46	15.1	24.4	30
A32M-A20M-U-SS	32mm	20mm	77.8	42	50	46	15.9	26	32
A32M-A25M-U-SS	32mm	25mm	82.3	42	50	46	21.8	31.3	38
A38M-A20M-U-SS	38mm	20mm	87.5	49.4	60	55	15.9	26	32
A38M-A25M-U-SS	38mm	25mm	92	49.4	60	55	21.8	31.3	38
A38M-A30M-U-SS	38mm	30mm	104.6	49.4	60	55	26.2	39.6	50

公制转英制

型号	接口尺寸		尺寸 mm						
	端口1	端口2	L	C	G	F	E	CX	GX
A3M-A2-U-SS	3mm	1/8in.	35.2	12.7	11.1	12	2.3	12.9	12
A4M-A4-U-SS	4mm	1/4in.	39.4	15.2	14.3	14	2.4	13.7	12
A4M-A2-U-SS	4mm	1/8in.	36.5	13.7	12	2.4	2.4	12.7	11.1
A6M-A4-U-SS	6mm	1/4in.	41.2	15.2	14.3	14	4.8	15.3	14
A6M-A6-U-SS	6mm	3/8in.	43.7	16.8	17.5	16	4.8	15.3	14
A6M-A8-U-SS	6mm	1/2in.	47.7	22.9	22.2	22	4.8	15.3	14
A6M-A2-U-SS	6mm	1/8in.	38.5	15.3	14	14	2.4	12.7	11.1
A8M-A6-U-SS	8mm	3/8in.	44.5	16.8	17.5	16	6.4	16.2	16
A8M-A4-U-SS	8mm	1/4in.	42.3	16.2	16	15	4.8	15.2	14.3
A10M-A8-U-SS	10mm	1/2in.	48.9	22.9	22.2	22	7.9	17.2	19
A10M-A2-U-SS	10mm	1/8in.	41.8	17.2	19	18	2.4	12.7	11.1
A10M-A4-U-SS	10mm	1/4in.	44.5	17.2	19	18	4.8	15.2	14.3
A10M-A5-U-SS	10mm	5/16in.	45.1	17.2	19	18	6.4	16.2	15.9
A10M-A6-U-SS	10mm	3/8in.	45.9	17.2	19	18	7.1	16.8	17.5
A12M-A8-U-SS	12mm	1/2in.	51.4	22.9	22.2	22	9.5	22.8	22
A12M-A12-U-SS	12mm	3/4in.	54.2	24.4	28.6	27	9.5	22.8	22
A12M-A5-U-SS	12mm	5/16in.	47.8	22.8	22	22	6.4	16.2	15.9
A12M-A6-U-SS	12mm	3/8in.	48.4	22.8	22	22	7.1	16.8	17.5
A15M-A8-U-SS	15mm	1/2in.	52	24.4	25	24	10.4	22.9	22.2
A16M-A12-U-SS	16mm	3/4in.	53.9	24.4	28.6	27	12.7	24.4	25
A16M-A10-U-SS	16mm	5/8in.	52	24.4	25	24	12.7	24.4	25.4
A18M-A12-U-SS	18mm	3/4in.	53.6	24.4	28.6	27	15.1	24.4	30
A20M-A8-U-SS	20mm	1/2in.	55	26	32	30	10.4	22.9	22.2
A25M-A16-U-SS	25mm	1in.	67.4	31.2	38.1	35	21.8	31.3	38

等径卡套穿板直通

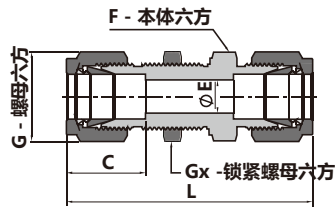

型号	接口类型和尺寸	尺寸 mm							
	卡套 in.	L	C	E	G	F	Gx	面板孔尺寸	最大面板厚度
BA1-U-SS	1/16	31.5	8.6	1.3	7.9	7.9	7.9	5.2	3
BA2-U-SS	1/8	51.3	12.7	2.3	11.1	12.7	12.7	8.3	12.7
BA3-U-SS	3/16	53.6	13.7	3	12.7	14.3	14.3	9.9	12.7
BA4-U-SS	1/4	57.7	15.2	4.8	14.3	15.9	15.9	11.5	10.2
BA5-U-SS	5/16	60.7	16.3	6.4	15.9	17.5	17.5	13.1	11.2
BA6-U-SS	3/8	62.2	16.8	7.1	17.5	19.1	19.1	14.7	11.2
BA8-U-SS	1/2	71.1	22.9	10.4	22.2	23.8	23.8	19.4	12.7
BA10-U-SS	5/8	72.6	24.4	12.7	25.4	27	27	22.6	12.7
BA12-U-SS	3/4	79	24.4	15.7	28.6	30.2	30.2	25.8	16.8
BA14-U-SS	7/8	85.2	25.9	18.3	31.8	34.9	34.9	29	19.1
BA16-U-SS	1	95.8	31.2	22.4	38.1	41.3	41.3	33.7	19.1
BA20-U-SS	1 1/4	123	41.1	27.8	47.6	47.6	47.6	41.7	19.1
BA24-U-SS	1 1/2	139	50	34	57.2	57.2	57.2	49.6	19.1

型号	接口类型和尺寸	尺寸 mm							
	卡套 mm	L	C	E	G	F	Gx	面板孔尺寸	最大面板厚度
BA3M-U-SS	3	51.3	12.9	2.4	12	14	14	8.3	12.7
BA4M-U-SS	4	53.6	13.7	2.4	12	14	14	9.9	12.7
BA6M-U-SS	6	57.7	15.3	4.8	14	16	16	11.5	10.2
BA8M-U-SS	8	61	16.2	6.4	16	18	18	13.1	11.2
BA10M-U-SS	10	63.7	17.2	7.9	19	22	22	16.3	11.2
BA12M-U-SS	12	71	22.8	9.5	22	24	24	19.5	12.7
BA14M-U-SS	14	72.5	24.4	11.1	25	27	27	22.5	12.7
BA15M-U-SS	15	72.5	24.4	11.9	25	27	27	22.8	12.7
BA16M-U-SS	16	72.5	24.4	12.7	25	27	27	22.8	12.7
BA18M-U-SS	18	78.9	24.4	15.1	30	30	30	26	16.8
BA20M-U-SS	20	84.5	26	15.9	32	35	35	29	19
BA25M-U-SS	25	96	31.3	21.8	38	41	41	34	19
BA30M-U-SS	30	124	39.6	26.2	50	50	50	40.5	19
BA32M-U-SS	32	128	42	28.6	50	50	50	42.5	19
BA38M-U-SS	38	145	49.4	33.7	60	60	60	50.5	19

变径卡套穿板直通

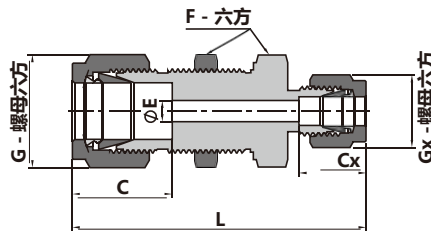

型号	接口类型和尺寸		尺寸 mm								
	端口1卡套	端口2卡套	L	C	E	G	F	CX	GX	面板孔尺寸	最大面板厚度
BA6M-A3M-U-SS	6mm	3mm	55.1	15.3	2.4	14	16	12.9	12	11.5	10.2
BA8M-A6M-U-SS	8mm	6mm	60.1	16.2	4.8	16	18	15.3	14	13.1	11.2
BA12M-A8M-U-SS	12mm	8mm	67.6	22.8	6.4	22	24	16.2	16	19.5	12.7
BA6M-A4-U-SS	6mm	1/4in.	57.7	15.2	4.8	14.3	15.9	15.3	14	11.5	10.2
BA6M-A2-U-SS	6mm	1/8in.	55.1	15.3	2.3	14	16	12.7	11	11.5	10.2
BA6M-A4-U-SS	6mm	1/4in.	57.7	15.3	4.8	14	16	15.2	14.3	11.5	10.2

英制卡套-NPT外螺纹直通

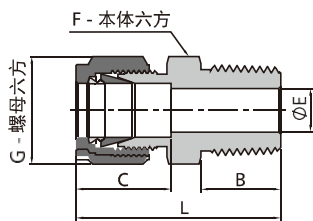

注：RC螺纹尺寸与NPT螺纹相同，对应型号中只需把M变为MRC，如A4-MRC4-U-SS

型号	接口类型和尺寸		尺寸 mm					
	端口1 卡套 in.	端口2 MNPT in.	L	B	C	E	G	F
A1-M1-U-SS	1/16	1/16	23.9	9.7	8.6	1.3	7.9	7.9
A1-M2-U-SS	1/16	1/8	26.2	9.7	8.6	1.3	7.9	11.1
A1-M4-U-SS	1/16	1/4	31	14.2	8.6	1.3	7.9	14.3
A2-M1-U-SS	1/8	1/16	29.7	9.7	12.7	2.3	11.1	11.1
A2-M2-U-SS	1/8	1/8	30.5	9.7	12.7	2.3	11.1	11.1
A2-M4-U-SS	1/8	1/4	35.6	14.2	12.7	2.3	11.1	14.3
A2-M6-U-SS	1/8	3/8	35.8	14.2	12.7	2.3	11.1	17.5
A2-M8-U-SS	1/8	1/2	42.2	19.1	12.7	2.3	11.1	22.2
A3-M1-U-SS	3/16	1/16	31.2	9.7	13.7	3	12.7	11.1
A3-M2-U-SS	3/16	1/8	31.2	9.7	13.7	3	12.7	11.1
A3-M4-U-SS	3/16	1/4	36.3	14.2	13.7	3	12.7	14.3
A4-M1-U-SS	1/4	1/16	32.8	9.7	15.2	3	14.3	12.7
A4-M2-U-SS	1/4	1/8	32.8	9.7	15.2	4.8	14.3	12.7
A4-M4-U-SS	1/4	1/4	37.8	14.2	15.2	4.8	14.3	14.3
A4-M6-U-SS	1/4	3/8	38.4	14.2	15.2	4.8	14.3	17.5
A4-M8-U-SS	1/4	1/2	44.7	19.1	15.2	4.8	14.3	22.2
A4-M12-U-SS	1/4	3/4	46.2	19.1	15.2	4.8	14.3	27
A5-M2-U-SS	5/16	1/8	34	9.7	16.3	4.8	15.9	14.3
A5-M4-U-SS	5/16	1/4	38.6	9.7	16.3	6.4	15.9	14.3
A5-M6-U-SS	5/16	3/8	39.1	14.2	16.3	6.4	15.9	17.5
A5-M8-U-SS	5/16	1/2	45.5	19.1	16.3	6.4	15.9	22.2
A6-M2-U-SS	3/8	1/8	35.3	9.7	16.8	4.8	17.5	15.9
A6-M4-U-SS	3/8	1/4	39.9	14.2	16.8	7.1	17.5	15.9
A6-M6-U-SS	3/8	3/8	39.9	14.2	16.8	7.1	17.5	17.5
A6-M8-U-SS	3/8	1/2	46.2	19.1	16.8	7.1	17.5	22.2
A6-M12-U-SS	3/8	3/4	47.8	19.1	16.8	7.1	17.5	27
A6-M16-U-SS	3/8	1	54.4	23.9	16.8	7.1	17.5	34.9
A8-M2-U-SS	1/2	1/8	38.9	9.7	22.9	4.8	22.2	20.6
A8-M4-U-SS	1/2	1/4	43.4	14.2	22.9	7.1	22.2	20.6
A8-M6-U-SS	1/2	3/8	43.4	14.2	22.9	9.7	22.2	20.6
A8-M8-U-SS	1/2	1/2	49	19.1	22.9	10.4	22.2	22.2
A8-M12-U-SS	1/2	3/4	50.5	19.1	22.9	10.4	22.2	27
A8-M16-U-SS	1/2	1	57.2	23.9	22.9	10.4	22.2	34.9
A10-M4-U-SS	5/8	1/4	44.2	14.2	24.4	7.1	25.4	23.8
A10-M6-U-SS	5/8	3/8	44.2	14.2	24.4	9.7	25.4	23.8
A10-M8-U-SS	5/8	1/2	49	19.1	24.4	11.9	25.4	23.8
A10-M12-U-SS	5/8	3/4	50.5	19.1	24.4	12.7	25.4	27
A12-M6-U-SS	3/4	3/8	45.7	14.2	24.4	10.4	28.6	27
A12-M8-U-SS	3/4	1/2	50.5	19.1	24.4	11.9	28.6	27
A12-M12-U-SS	3/4	3/4	50.5	19.1	24.4	15.7	28.6	27
A12-M16-U-SS	3/4	1	57.2	23.9	24.4	15.7	28.6	34.9
A14-M8-U-SS	7/8	1/2	50.5	19.1	25.9	11.9	31.8	30.2
A14-M12-U-SS	7/8	3/4	50.5	19.1	25.9	15.7	31.8	30.2
A14-M16-U-SS	7/8	1	57.2	23.9	25.9	18.3	31.8	34.9
A16-M8-U-SS	1	1/2	57.4	19.1	31.2	11.9	38.1	34.9
A16-M12-U-SS	1	3/4	57.4	19.1	31.2	15.7	38.1	34.9
A16-M16-U-SS	1	1	62.2	23.9	31.2	22.4	38.1	34.9
A18-M16-U-SS	1 1/8	1	62.2	23.9	36.7	22.4	44.5	41.3
A20-M16-U-SS	1 1/4	1	77.2	23.9	41.1	22.4	47.6	44.5
A20-M20-U-SS	1 1/4	1 1/4	77.2	23.9	41.1	27.7	47.6	44.5
A24-M24-U-SS	1 1/2	1 1/2	88.9	26.2	50	34	57.2	54

公制卡套-NPT外螺纹直通

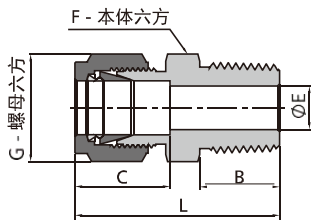

注：RC螺纹尺寸与NPT螺纹相同，对应型号中只需把M变为MRC，如A6M-MRC4-U-SS

型号	接口类型和尺寸		尺寸 mm					
	端口1 卡套 mm	端口2 MNPT in.	L	B	C	E	G	F
A2M-M2-U-SS	2	1/8	30.5	9.7	12.9	1.7	12	12
A3M-M2-U-SS	3	1/8	30.5	9.7	12.9	2.4	12	12
A3M-M4-U-SS	3	1/4	35.6	14.2	12.9	2.4	12	14
A4M-M2-U-SS	4	1/8	31.2	9.7	13.7	2.4	12	12
A4M-M4-U-SS	4	1/4	36.3	14.2	13.7	2.4	12	14
A6M-M2-U-SS	6	1/8	32.8	9.7	15.3	4.8	14	14
A6M-M4-U-SS	6	1/4	37.9	14.2	15.3	4.8	14	14
A6M-M6-U-SS	6	3/8	38.4	14.2	15.3	4.8	14	18
A6M-M8-U-SS	6	1/2	44.7	19.1	15.3	4.8	14	22
A8M-M2-U-SS	8	1/8	34.2	9.7	16.2	4.8	16	15
A8M-M4-U-SS	8	1/4	38.7	14.2	16.2	6.4	16	15
A8M-M6-U-SS	8	3/8	39.3	14.2	16.2	6.4	16	18
A8M-M8-U-SS	8	1/2	45.6	19.1	16.2	6.4	16	22
A10M-M2-U-SS	10	1/8	36.3	9.7	17.2	4.8	19	18
A10M-M4-U-SS	10	1/4	40.9	14.2	17.2	7.1	19	18
A10M-M6-U-SS	10	3/8	40.9	14.2	17.2	7.9	19	18
A10M-M8-U-SS	10	1/2	46.5	19.1	17.2	7.9	19	22
A10M-M12-U-SS	10	3/4	48	19.1	17.2	7.9	19	27
A10M-M16-U-SS	10	1	54.6	23.9	17.2	7.9	19	35
A12M-M2-U-SS	12	1/8	38.8	9.7	22.8	4.8	22	22
A12M-M4-U-SS	12	1/4	43.4	14.2	22.8	7.1	22	22
A12M-M6-U-SS	12	3/8	43.4	14.2	22.8	9.5	22	22
A12M-M8-U-SS	12	1/2	49	19.1	22.8	9.5	22	22
A12M-M12-U-SS	12	3/4	50.5	19.1	22.8	9.5	22	27
A14M-M2-U-SS	14	1/8	39.9	9.7	24.4	4.8	25	24
A14M-M4-U-SS	14	1/4	44.1	14.2	24.4	7.1	25	24
A14M-M6-U-SS	14	3/8	44.1	14.2	24.4	9.5	25	24
A14M-M8-U-SS	14	1/2	49	19.1	24.4	11.1	25	24
A14M-M12-U-SS	14	3/4	49.1	19.1	24.4	11.1	25	27
A15M-M8-U-SS	15	1/2	49	19.1	24.4	11.9	25	24
A15M-M12-U-SS	15	3/4	50.5	19.1	24.4	11.9	25	27
A15M-M16-U-SS	15	1	57.1	23.9	24.4	11.9	25	35
A16M-M4-U-SS	16	1/4	44.1	14.2	24.4	7.1	25	24
A16M-M6-U-SS	16	3/8	44.1	14.2	24.4	9.5	25	24
A16M-M8-U-SS	16	1/2	49	19.1	24.4	11.9	25	24
A16M-M12-U-SS	16	3/4	50.5	19.1	24.4	12.7	25	27
A18M-M6-U-SS	18	3/8	45.6	14.2	24.4	9.5	30	27
A18M-M8-U-SS	18	1/2	50.5	19.1	24.4	11.9	30	27
A18M-M12-U-SS	18	3/4	50.5	19.1	24.4	15.1	30	27
A20M-M8-U-SS	20	1/2	52.3	19.1	26	11.9	32	30
A20M-M12-U-SS	20	3/4	52.3	19.1	26	15.9	32	30
A20M-M16-U-SS	20	1	57.1	23.9	26	15.9	32	35
A22M-M8-U-SS	22	1/2	52.3	19.1	26	11.9	32	30
A22M-M12-U-SS	22	3/4	52.3	19.1	26	15.9	32	30
A22M-M16-U-SS	22	1	57.1	23.9	26	18.3	32	35
A25M-M8-U-SS	25	1/2	57.5	19.1	31.3	11.9	38	35
A25M-M12-U-SS	25	3/4	57.5	19.1	31.3	15.9	38	35
A25M-M16-U-SS	25	1	62.3	23.9	31.3	21.8	38	35
A28M-M16-U-SS	28	1	72.4	23.9	36.6	21.8	46	41
A28M-M20-U-SS	28	1 1/4	73.1	23.9	36.6	21.8	46	46
A30M-M20-U-SS	30	1 1/4	77.2	23.9	39.6	26.2	50	46
A32M-M20-U-SS	32	1 1/4	79.6	23.9	42	28.6	50	46
A38M-M24-U-SS	38	1 1/2	91.6	26.2	49.4	33.7	60	55

卡套-NPT外螺纹穿板直通接头

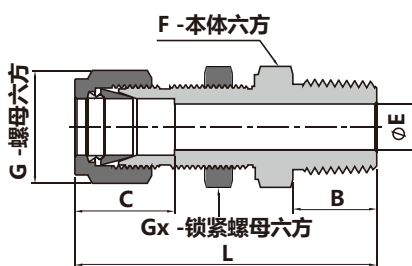

注: RC螺纹尺寸与NPT螺纹相同, 对应型号中只需把M变为MRC, 如BA6M-MRC4-U-SS

型号	接口类型和尺寸		尺寸 mm								
	端口1 卡套 in.	端口2 MNPT in.	L	B	C	E	G	F	GX	面板 孔尺寸	最大 面板 厚度
BA1-M1-U-SS	1/16	1/16	30.2	9.7	8.6	1.3	7.9	7.9	7.9	5.2	6.4
BA1-M2-U-SS	1/16	1/8	32.3	9.7	8.6	1.3	7.9	11.1	7.9	5.2	6.4
BA2-M2-U-SS	1/8	1/8	46.5	9.7	12.7	2.3	11.1	12.7	12.7	8.3	12.7
BA3-M2-U-SS	3/16	1/8	48	9.7	13.7	3	12.7	14.3	14.3	9.9	12.7
BA4-M2-U-SS	1/4	1/8	49.5	9.7	15.2	4.8	14.3	15.9	15.9	11.5	10.2
BA4-M4-U-SS	1/4	1/4	54.1	14.2	15.2	4.8	14.3	15.9	15.9	11.5	10.2
BA4-M6-U-SS	1/4	3/8	54.9	14.2	15.2	4.8	14.3	17.5	15.9	11.5	10.2
BA4-M8-U-SS	1/4	1/2	60.3	19.1	15.2	4.8	14.3	22.2	15.9	11.5	10.2
BA5-M2-U-SS	5/16	1/8	52.8	9.7	16.3	4.8	15.9	17.5	17.5	13.1	11.2
BA5-M4-U-SS	5/16	1/4	57.7	14.2	16.3	6.4	15.9	17.5	17.5	13.1	11.2
BA6-M2-U-SS	3/8	1/8	52.9	9.7	16.8	4.8	17.5	19.1	19.1	14.7	11.2
BA6-M4-U-SS	3/8	1/4	57.4	14.2	16.8	7.1	17.5	19.1	19.1	14.7	11.2
BA6-M6-U-SS	3/8	3/8	57.4	14.2	16.8	7.1	17.5	19.1	19.1	14.7	11.2
BA6-M8-U-SS	3/8	1/2	63.8	19.1	16.8	7.1	17.5	22.2	22.2	14.7	11.2
BA8-M2-U-SS	1/2	1/8	58.7	9.7	22.9	4.8	22.2	23.8	23.8	19.4	12.7
BA8-M4-U-SS	1/2	1/4	56.6	14.2	22.9	7.1	22.2	23.8	23.8	19.4	12.7
BA8-M6-U-SS	1/2	3/8	63.2	14.2	22.9	9.7	22.2	23.8	23.8	19.4	12.7
BA8-M8-U-SS	1/2	1/2	68.8	19.1	22.9	10.4	22.2	23.8	23.8	19.4	12.7
BA10-M6-U-SS	5/8	3/8	66.7	14.2	24.4	9.7	25.4	27	27	22.6	15.1
BA10-M8-U-SS	5/8	1/2	71.5	19.1	24.4	11.9	25.4	27	27	22.6	15.1
BA12-M8-U-SS	3/4	1/2	76.2	19.1	24.4	11.9	28.6	30.2	30.2	25.8	16.8
BA12-M12-U-SS	3/4	3/4	76.2	19.1	24.4	15.7	28.6	30.2	30.2	25.8	16.8
BA14-M12-U-SS	7/8	3/4	84.1	19.1	25.9	15.7	31.8	33.3	33.3	29	19.1
BA16-M12-U-SS	1	3/4	88.4	19.1	31.2	15.7	38.1	41.3	41.3	33.7	19.1
BA16-M16-U-SS	1	1	93.2	23.9	31.2	22.4	38.1	41.3	41.3	33.7	19.1

型号	接口类型和尺寸		尺寸 mm								
	端口1 卡套 mm	端口2 MNPT in.	L	B	C	E	G	F	GX	面板 孔尺寸	最大 面板 厚度
BA6M-M2-U-SS	6	1/8	49.6	9.7	15.3	4.8	14	16	16	11.5	10.2
BA6M-M4-U-SS	6	1/4	53.6	14.2	15.3	4.8	14	16	16	11.5	10.2
BA8M-M2-U-SS	8	1/8	52.3	9.7	16.2	4.8	16	18	18	13.1	11.2
BA8M-M4-U-SS	8	1/4	56.6	14.2	16.2	6.4	16	18	18	13.1	11.2
BA10M-M4-U-SS	10	1/4	58.4	14.2	17.2	7.1	19	22	22	16.3	11.2
BA10M-M6-U-SS	10	3/8	58.4	14.2	17.2	7.9	19	22	22	16.3	11.2
BA10M-M8-U-SS	10	1/2	63.1	19.1	17.2	7.9	19	22	22	16.3	11.2
BA12M-M4-U-SS	12	1/4	63.9	14.2	22.8	7.1	22	24	24	19.5	12.7
BA12M-M6-U-SS	12	3/8	63.9	14.2	22.8	9.5	22	24	24	19.5	12.7
BA12M-M8-U-SS	12	1/2	68.8	19.1	22.8	9.5	22	24	24	19.5	12.7

卡套-NPT外螺纹直通 (O型圈密封)

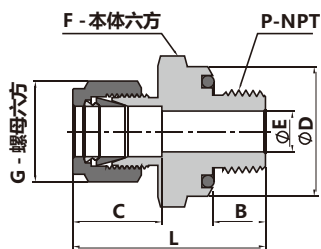

型号	接口类型和尺寸		尺寸 mm						
	端口1 卡套 in.	端口2NPT 外螺纹 +O型圈	L	B	C	E	G	F	D
A2-MO2-U-SS	1/8	1/8	32.8	7.1	8.6	2.3	11.9	19.1	18.8
A4-MO2-U-SS	1/4	1/8	35.1	7.1	15.2	4.8	14.3	19.1	18.8
A4-MO4-U-SS	1/4	1/4	38.4	9.7	15.2	4.8	14.3	23.8	23.6
A6-MO4-U-SS	3/8	1/4	39.9	9.7	16.8	7.1	17.5	23.8	23.6
A6-MO6-U-SS	3/8	3/8	41.4	10.4	16.8	7.1	17.5	28.6	28.4
A6-MO8-U-SS	3/8	1/2	47	13.5	16.8	7.1	17.5	33.3	33

英制卡套-ISO平行外螺纹直通 (根部复合垫片密封)

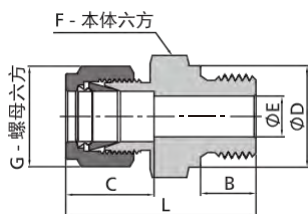

型号	接口类型和尺寸		尺寸 mm						
	端口1 卡套 in.	端口2 ISO平行外螺纹 in.	L	B	C	E	G	F	D
A2-MGA2-U-SS	1/8	1/8	30	7.1	12.7	2.3	11.1	14.3	13.7
A2-MGA4-U-SS	1/8	1/4	35.3	11.2	12.7	2.3	11.1	19.1	18
A2-MGA6-U-SS	1/8	3/8	36.3	11.2	12.7	2.3	11.1	22.2	21.8
A4-MGA2-U-SS	1/4	1/8	32.3	7.1	15.2	4	14.3	14.3	13.7
A4-MGA4-U-SS	1/4	1/4	37.6	11.2	15.2	4.8	14.3	19.1	18
A4-MGA6-U-SS	1/4	3/8	38.9	11.2	15.2	4.8	14.3	22.2	21.8
A4-MGA8-U-SS	1/4	1/2	44.7	14.2	15.2	4.8	14.3	27	25.9
A6-MGA2-U-SS	3/8	1/8	37.8	7.1	16.8	4	17.5	15.9	13.7
A6-MGA4-U-SS	3/8	1/4	39.1	11.2	16.8	5.9	17.5	19.1	18
A6-MGA6-U-SS	3/8	3/8	40.4	11.2	16.8	7.1	17.5	22.2	21.8
A6-MGA8-U-SS	3/8	1/2	46.2	14.2	16.8	7.1	17.5	27	25.9
A8-MGA4-U-SS	1/2	1/4	42.7	11.2	22.9	5.9	22.2	20.6	18
A8-MGA6-U-SS	1/2	3/8	43.2	11.2	22.9	7.9	22.2	22.2	21.8
A8-MGA8-U-SS	1/2	1/2	49	14.2	22.9	10.4	22.2	27	25.9
A12-MGA8-U-SS	3/4	1/2	49	14.2	24.4	11.9	28.6	27	25.9
A12-MGA12-U-SS	3/4	3/4	52.9	15.7	24.4	15.7	28.6	33.3	32
A16-MGA8-U-SS	1	1/2	55.5	14.2	31.2	11.9	38.1	34.9	25.9
A16-MGA12-U-SS	1	3/4	57.7	15.7	31.2	16	38.1	34.9	32
A16-MGA16-U-SS	1	1	59.9	18.3	31.2	19.8	38.1	41.3	39.1

公制卡套-ISO平行外螺纹直通 (根部复合垫片密封)

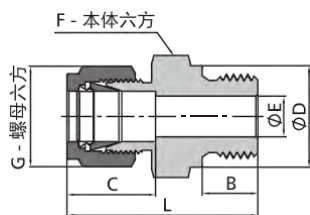

型号	接口类型和尺寸		尺寸 mm						
	端口1 卡套 mm	端口2 ISO平行外螺纹 in.	L	B	C	E	G	F	D
A2M-MGA2-U-SS	2	1/8	30	7.1	12.9	1.7	12	14	13.7
A3M-MGA2-U-SS	3	1/8	30	7.1	12.9	2.4	12	14	13.7
A3M-MGA4-U-SS	3	1/4	35.3	11.2	12.9	2.4	12	19	18
A4M-MGA2-U-SS	4	1/8	30.7	7.1	13.7	2.4	12	14	13.7
A4M-MGA4-U-SS	4	1/4	36	11.2	13.7	2.4	12	19	18
A6M-MGA2-U-SS	6	1/8	32.3	7.1	15.3	4	14	14	13.7
A6M-MGA4-U-SS	6	1/4	37.6	11.2	15.3	4.8	14	19	18
A6M-MGA6-U-SS	6	3/8	38.9	11.2	15.3	4.8	14	22	21.6
A6M-MGA8-U-SS	6	1/2	44.7	14.2	15.3	4.8	14	27	25.9
A8M-MGA2-U-SS	8	1/8	33.2	7.1	16.2	4	16	15	13.7
A8M-MGA4-U-SS	8	1/4	38.5	11.2	16.2	6.4	16	19	18
A8M-MGA6-U-SS	8	3/8	39.8	11.2	16.2	6.4	16	22	21.6
A8M-MGA8-U-SS	8	1/2	45.6	14.2	16.2	6.4	16	27	25.9
A8M-MGA12-U-SS	8	3/4	49.5	15.7	16.2	6.4	16	35	32
A10M-MGA4-U-SS	10	1/4	39.4	11.2	17.2	5.9	19	19	18
A10M-MGA6-U-SS	10	3/8	40.6	11.2	17.2	7.9	19	22	21.6
A10M-MGA8-U-SS	10	1/2	46.5	14.2	17.2	7.9	19	27	25.9
A12M-MGA4-U-SS	12	1/4	42.6	11.2	22.8	5.9	22	22	18
A12M-MGA6-U-SS	12	3/8	43.1	11.2	22.8	7.9	22	22	21.6
A12M-MGA8-U-SS	12	1/2	49	14.2	22.8	9.5	22	27	25.9
A12M-MGA12-U-SS	12	3/4	52.8	15.7	22.8	9.5	22	35	32
A14M-MGA4-U-SS	14	1/4	44.2	11.2	24.4	6.4	25	24	18
A14M-MGA6-U-SS	14	3/8	43.9	11.2	24.4	7.9	25	24	21.6
A14M-MGA8-U-SS	14	1/2	49	14.2	24.4	11.1	25	27	25.9
A14M-MGA12-U-SS	14	3/4	52.8	15.7	24.4	11.1	25	35	32
A15M-MGA6-U-SS	15	3/8	43.9	11.2	24.4	7.9	25	24	21.6
A15M-MGA8-U-SS	15	1/2	49	14.2	24.4	11.9	25	27	25.9
A15M-MGA12-U-SS	15	3/4	52.8	15.7	24.4	11.9	25	35	32
A16M-MGA6-U-SS	16	3/8	43.9	11.2	24.4	7.9	25	24	21.6
A16M-MGA8-U-SS	16	1/2	49	14.2	24.4	11.9	25	27	25.9
A16M-MGA12-U-SS	16	3/4	52.8	15.7	24.4	12.7	25	35	32
A18M-MGA8-U-SS	18	1/2	49	14.2	24.4	11.9	30	27	25.9
A18M-MGA12-U-SS	18	3/4	52.8	15.7	24.4	15.1	30	35	32
A20M-MGA8-U-SS	20	1/2	50.5	14.2	26	11.9	32	30	25.9
A20M-MGA12-U-SS	20	3/4	52.8	15.7	26	15.9	32	35	32
A22M-MGA12-U-SS	22	3/4	52.8	15.7	26	15.9	32	35	32
A22M-MGA16-U-SS	22	1	55.3	18.3	26	18.3	32	41	39.1
A25M-MGA12-U-SS	25	3/4	57.5	15.7	31.3	15.9	38	35	32
A25M-MGA16-U-SS	25	1	60.1	18.3	31.3	19.8	38	41	39.1
A28M-MGA16-U-SS	28	1	70.1	18.3	36.6	19.8	46	41	39.1
A28M-MGA20-U-SS	28	1 1/4	73.9	19.8	36.6	21.8	46	50	49
A30M-MGA20-U-SS	30	1 1/4	76.5	19.8	39.6	26.2	50	50	49
A32M-MGA20-U-SS	32	1 1/4	79.2	19.8	42	28.6	50	50	49
A38M-MGA24-U-SS	38	1 1/2	90.8	20.6	49.4	31.8	60	55	54.7

英制卡套-ISO平行外螺纹直通 (根部金属垫片或O型圈密封)

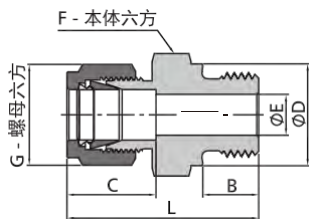

型号	接口类型和尺寸		尺寸 mm						
	端口1 卡套 in.	端口2 ISO平行外螺纹 in.	L	B	C	E	G	F	D
A2-MGB2-U-SS	1/8	1/8	30	7.1	12.7	2.3	11.1	14.3	13.8
A2-MGB4-U-SS	1/8	1/4	35.3	11.2	12.7	2.3	11.1	19.1	17.8
A2-MGB6-U-SS	1/8	3/8	36.3	11.2	12.7	2.3	11.1	22.2	21.8
A4-MGB2-U-SS	1/4	1/8	32.3	7.1	15.2	4.1	14.3	14.3	13.8
A4-MGB4-U-SS	1/4	1/4	37.6	11.2	15.2	4.8	14.3	19.1	17.8
A4-MGB6-U-SS	1/4	3/8	38.9	11.2	15.2	4.8	14.3	22.2	21.8
A4-MGB8-U-SS	1/4	1/2	44.7	14.2	15.2	4.8	14.3	27	25.9
A6-MGB2-U-SS	3/8	1/8	37.8	7.1	16.8	4	17.5	15.9	13.7
A6-MGB4-U-SS	3/8	1/4	39.1	11.2	16.8	5.9	17.5	19.1	18
A6-MGB6-U-SS	3/8	3/8	40.4	11.2	16.8	7.1	17.5	22.2	21.8
A6-MGB8-U-SS	3/8	1/2	46.2	14.2	16.8	7.1	17.5	27	25.9
A8-MGB4-U-SS	1/2	1/4	42.7	11.2	22.9	5.9	22.2	20.6	18
A8-MGB6-U-SS	1/2	3/8	45.5	11.2	22.9	7.9	22.2	22.2	21.8
A8-MGB8-U-SS	1/2	1/2	49	14.2	22.9	10.4	22.2	27	25.9
A12-MGB8-U-SS	3/4	1/2	49	14.2	24.4	11.9	28.6	27	25.9
A12-MGB12-U-SS	3/4	3/4	52.9	15.7	24.4	15.7	28.6	33.3	32
A16-MGB8-U-SS	1	1/2	55.5	14.2	31.2	11.9	38.1	34.9	25.9
A16-MGB12-U-SS	1	3/4	57.7	15.7	31.2	16	38.1	34.9	32
A16-MGB16-U-SS	1	1	59.9	18.3	31.2	19.8	38.1	41.3	39.1

公制卡套-ISO平行外螺纹直通 (根部金属垫片或O型圈密封)

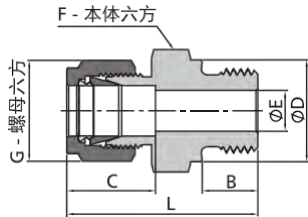

型号	接口类型和尺寸		尺寸 mm						
	端口1 卡套 mm	端口2 ISO平行外螺纹 in.	L	B	C	E	G	F	D
A2M-MGB2-U-SS	2	1/8	30	7.1	12.9	1.7	12	14	13.7
A3M-MGB2-U-SS	3	1/8	30	7.1	12.9	2.4	12	14	13.7
A3M-MGB4-U-SS	3	1/4	35.3	11.2	12.9	2.4	12	19	18
A4M-MGB2-U-SS	4	1/8	30.7	7.1	13.7	2.4	12	14	13.8
A4M-MGB4-U-SS	4	1/4	36	11.2	13.7	2.4	12	19	18
A6M-MGB2-U-SS	6	1/8	32.3	7.1	15.3	4	14	14	13.7
A6M-MGB4-U-SS	6	1/4	37.6	11.2	15.3	4.8	14	19	18
A6M-MGB6-U-SS	6	3/8	38.9	11.2	15.3	4.8	14	22	21.8
A6M-MGB8-U-SS	6	1/2	44.7	14.2	15.3	4.8	14	27	26
A8M-MGB2-U-SS	8	1/8	33.3	7.1	16.2	4	16	15	13.7
A8M-MGB4-U-SS	8	1/4	38.5	11.2	16.2	5.9	16	19	18
A8M-MGB6-U-SS	8	3/8	39.8	11.2	16.2	6.4	16	22	21.8
A8M-MGB8-U-SS	8	1/2	45.6	14.2	16.2	6.4	16	27	26
A8M-MGB12-U-SS	8	3/4	49.5	15.7	16.2	6.4	16	35	32
A10M-MGB4-U-SS	10	1/4	39.4	11.2	17.2	5.9	19	19	18
A10M-MGB6-U-SS	10	3/8	42.8	11.2	17.2	7.9	19	22	21.8
A10M-MGB8-U-SS	10	1/2	46.5	14.2	17.2	7.9	19	27	26
A12M-MGB4-U-SS	12	1/4	42.6	11.2	22.8	5.9	22	22	18
A12M-MGB6-U-SS	12	3/8	43.1	11.2	22.8	7.9	22	22	21.8
A12M-MGB8-U-SS	12	1/2	49	14.2	22.8	9.5	22	27	26
A12M-MGB12-U-SS	12	3/4	52.8	15.7	22.8	9.5	22	35	32
A14M-MGB4-U-SS	14	1/4	44.2	11.2	24.4	6.4	25	24	18
A14M-MGB6-U-SS	14	3/8	43.9	11.2	24.4	7.9	25	24	21.6
A14M-MGB8-U-SS	14	1/2	49	14.2	24.4	11.1	25	27	25.9
A14M-MGB12-U-SS	14	3/4	52.8	15.7	24.4	11.1	25	35	32
A15M-MGB6-U-SS	15	3/8	43.9	11.2	24.4	7.9	25	24	21.6
A15M-MGB8-U-SS	15	1/2	49	14.2	24.4	11.9	25	27	25.9
A15M-MGB12-U-SS	15	3/4	52.8	15.7	24.4	11.9	25	35	32
A16M-MGB6-U-SS	16	3/8	43.9	11.2	24.4	7.9	25	24	21.8
A16M-MGB8-U-SS	16	1/2	49	14.2	24.4	11.9	25	27	26
A16M-MGB12-U-SS	16	3/4	52.8	15.7	24.4	12.7	25	35	32
A18M-MGB8-U-SS	18	1/2	49	14.2	24.4	11.9	30	27	26
A18M-MGB12-U-SS	18	3/4	52.8	15.7	24.4	15.1	30	35	32
A20M-MGB8-U-SS	20	1/2	50.5	14.2	26	11.9	32	30	26
A20M-MGB12-U-SS	20	3/4	52.8	15.7	26	15.9	32	35	32
A22M-MGB12-U-SS	22	3/4	52.8	15.7	26	15.9	32	35	32
A22M-MGB16-U-SS	22	1	55.3	18.3	26	18.3	32	41	39
A25M-MGB12-U-SS	25	3/4	57.5	15.7	31.3	15.9	38	35	32
A25M-MGB16-U-SS	25	1	60.1	18.3	31.3	19.8	38	41	39
A28M-MGB16-U-SS	28	1	70.1	18.3	36.6	19.8	46	41	39
A28M-MGB20-U-SS	28	1 1/4	73.9	19.8	36.6	21.8	46	50	49
A30M-MGB20-U-SS	30	1 1/4	76.5	19.8	39.6	26.2	50	50	49
A32M-MGB20-U-SS	32	1 1/4	78.9	19.8	42	28.6	50	50	49
A38M-MGB24-U-SS	38	1 1/2	89.3	20.6	49.4	31.8	60	55	54.7

卡套-ISO平行外螺纹直通 (顶部金属垫片密封)

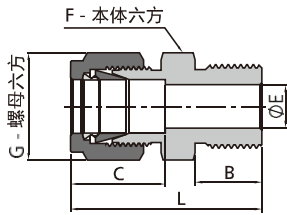

型号	接口类型和尺寸		尺寸 mm					
	端口1 卡套 in.	端口2 ISO平行外螺纹 in.	L	B	C	E	G	F
A4-MG6-U-SS	1/4	3/8	38.4	14.2	15.2	4.8	14.3	17.5
A6-MG6-U-SS	3/8	3/8	39.9	14.2	16.8	7.1	17.5	17.5

型号	接口类型和尺寸		尺寸 mm					
	端口1 卡套 mm	端口2 ISO平行外螺纹 in.	L	B	C	E	G	F
A6M-MG4-U-SS	6	1/4	36.9	12.9	15.3	4.8	14	14
A6M-MG6-U-SS	6	3/8	39.5	14.2	15.3	4.8	14	18
A8M-MG2-U-SS	8	1/8	33.9	9.8	16.2	4	16	14
A8M-MG4-U-SS	8	1/4	37	12.9	16.2	6.4	16	14
A8M-MG6-U-SS	8	3/8	39.3	14.2	16.2	6.4	16	18
A8M-MG8-U-SS	8	1/2	45.4	18.8	16.2	6.4	16	22
A10M-MG4-U-SS	10	1/4	39.5	12.9	17.2	5.9	19	18
A10M-MG8-U-SS	10	1/2	46.3	18.8	17.2	7.9	19	22
A12M-MG6-U-SS	12	3/8	44.2	14.2	22.8	7.9	22	22
A12M-MG8-U-SS	12	1/2	52.1	18.8	22.8	9.5	22	22
A14M-MG4-U-SS	14	1/4	42.9	12.9	24.4	5.9	25	24
A16M-MG6-U-SS	16	3/8	43.4	14.2	24.4	7.9	25	24
A16M-MG8-U-SS	16	1/2	47.9	18.8	24.4	9.5	25	24
A18M-MG8-U-SS	18	1/2	49.8	18.8	24.4	9.5	30	27

英制卡套-公制外螺纹直通 (顶部金属垫片密封)

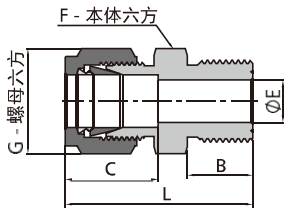

型号	接口类型和尺寸		尺寸 mm					
	端口1 卡套 in.	端口2 公制外螺纹 M	L	B	C	E	G	F
A1-MM5*0.8-U-SS	1/16	M5x0.8	21.8	8	8.6	1.3	7.9	7.9
A2-MM14*1.5-U-SS	1/8	M14x1.5	34.8	13	12.7	2.3	11.1	15.9
A2-MM16*1.5-U-SS	1/8	M16x1.5	35.8	14	12.7	2.3	11.1	17.5
A2-MM18*1.5-U-SS	1/8	M18x1.5	37.2	15	12.7	2.3	11.1	19.1
A2-MM20*1.5-U-SS	1/8	M20x1.5	38.1	16	12.7	2.3	11.1	22.2
A4-MM14*1.5-U-SS	1/4	M14x1.5	36.9	13	15.2	4.8	14.3	15.9
A4-MM16*1.5-U-SS	1/4	M16x1.5	38.1	14	15.2	4.8	14.3	17.5
A4-MM18*1.5-U-SS	1/4	M18x1.5	39.5	15	15.2	4.8	14.3	19.1
A4-MM20*1.5-U-SS	1/4	M20x1.5	40.7	16	15.2	4.8	14.3	22.2
A6-MM10*1.0-U-SS	3/8	M10x1.0	36.4	11	16.8	4.8	17.5	15.9
A6-MM14*1.5-U-SS	3/8	M14x1.5	39.3	13	16.8	7.1	17.5	15.9
A6-MM16*1.5-U-SS	3/8	M16x1.5	39.7	14	16.8	7.1	17.5	17.5
A6-MM18*1.5-U-SS	3/8	M18x1.5	41.5	15	16.8	7.1	17.5	19.1
A6-MM20*1.5-U-SS	3/8	M20x1.5	42.3	16	16.8	7.1	17.5	22.2
A8-MM16*1.5-U-SS	1/2	M16x1.5	43.2	14	22.9	8.4	22.2	20.6
A8-MM18*1.5-U-SS	1/2	M18x1.5	43.7	15	22.9	9.6	22.2	20.6
A8-MM20*1.5-U-SS	1/2	M20x1.5	44.9	16	22.9	10.4	22.2	22.2
A8-MM22*1.5-U-SS	1/2	M22x1.5	47	17	22.9	10.4	22.2	23.8

公制卡套-公制外螺纹直通 (顶部金属垫片密封)

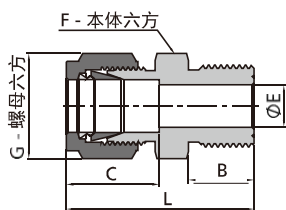

型号	接口类型和尺寸		尺寸 mm					
	端口1 卡套 mm	端口2 公制外螺纹 M	L	B	C	E	G	F
A6M-MM6*1-U-SS	6	M6x1	32.4	8	15.3	2	14	14
A6M-MM8*1-U-SS	6	M8x1	35.3	9	15.3	3	14	14
A6M-MM10*1-U-SS	6	M10x1	34.7	11	15.3	4.7	14	14
A6M-MM12*1.5-U-SS	6	M12x1.5	36.4	12	15.3	4.8	14	14
A6M-MM14*1.5-U-SS	6	M14x1.5	36.5	13	15.3	4.8	14	16
A6M-MM16*1.5-U-SS	6	M16x1.5	38.4	14	15.3	4.8	14	18
A6M-MM18*1.5-U-SS	6	M18x1.5	40	15	15.3	4.8	14	19
A6M-MM20*1.5-U-SS	6	M20x1.5	41.7	16	15.3	4.8	14	22
A8M-MM8*1-U-SS	8	M8x1	34.5	9	16.2	3	16	14
A8M-MM10*1-U-SS	8	M10x1	36.6	11	16.2	4.7	16	14
A8M-MM12*1.5-U-SS	8	M12x1.5	36.6	12	16.2	6	16	14
A8M-MM14*1.5-U-SS	8	M14x1.5	37.7	13	16.2	6.4	16	16
A8M-MM20*1.5-U-SS	8	M20x1.5	42.5	16	16.2	6.4	16	22
A10M-MM12*1.5-U-SS	10	M12x1.5	38.7	12	17.2	6	19	18
A10M-MM14*1.5-U-SS	10	M14x1.5	39.7	13	17.2	7.2	19	18
A10M-MM20*1.5-U-SS	10	M20x1.5	43.5	16	17.2	7.9	19	22
A12M-MM12*1.5-U-SS	12	M12x1.5	41.2	12	22.8	6	22	22
A12M-MM16*1.5-U-SS	12	M16x1.5	43.2	14	22.8	8.4	22	22
A12M-MM18*1.5-U-SS	12	M18x1.5	44.2	15	22.8	9.5	22	22
A12M-MM20*1.5-U-SS	12	M20x1.5	45.2	16	22.8	9.5	22	22
A14M-MM14*1.5-U-SS	14	M14x1.5	42.5	13	24.4	7.2	25	24
A14M-MM16*1.5-U-SS	14	M16x1.5	43.9	14	24.4	8.4	25	24
A14M-MM20*1.5-U-SS	14	M20x1.5	45.1	16	24.4	10.8	25	24
A16M-MM20*1.5-U-SS	16	M20x1.5	46.1	16	24.4	10.8	25	24
A18M-MM20*1.5-U-SS	18	M20x1.5	47.5	16	24.4	10.8	30	27
A18M-MM22*1.5-U-SS	18	M22x1.5	48.5	17	24.4	12	30	27
A20M-MM20*1.5-U-SS	20	M20x1.5	49.5	16	26	10.8	32	30
A22M-MM24*1.5-U-SS	22	M24x1.5	50.5	17	26	14.4	32	30
A25M-MM27*2-U-SS	25	M27x2	57	18	31.3	16.1	38	35

卡套-公制外螺纹直通 (外螺纹根部复合垫片密封)

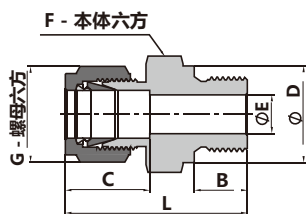

型号	接口类型和尺寸		尺寸 mm						
	端口1 卡套 in.	端口2 公制螺纹 M	L	B	C	E	G	F	D
A2-MRM14*1.5-U-SS	1/8	M14x1.5	36.7	12	12.7	2.3	11.1	19.1	19
A2-MRM16*1.5-U-SS	1/8	M16x1.5	37.5	12	12.7	2.3	11.1	22.2	21
A2-MRM18*1.5-U-SS	1/8	M18x1.5	38.5	12	12.7	2.3	11.1	23.8	23
A2-MRM20*1.5-U-SS	1/8	M20x1.5	41.1	14	12.7	2.3	11.1	25.4	25
A4-MRM14*1.5-U-SS	1/4	M14x1.5	38	12	15.2	4.8	14.3	19.1	19
A4-MRM16*1.5-U-SS	1/4	M16x1.5	39.9	12	15.2	4.8	14.3	22.2	21
A4-MRM18*1.5-U-SS	1/4	M18x1.5	40.8	12	15.2	4.8	14.3	23.8	23
A4-MRM20*1.5-U-SS	1/4	M20x1.5	43.6	14	15.2	4.8	14.3	25.4	25
A6-MRM14*1.5-U-SS	3/8	M14x1.5	41.3	12	16.8	7.1	17.5	19.1	19
A6-MRM16*1.5-U-SS	3/8	M16x1.5	41.3	12	16.8	7.1	17.5	22.2	21
A6-MRM18*1.5-U-SS	3/8	M18x1.5	41.8	12	16.8	7.1	17.5	23.8	23
A6-MRM20*1.5-U-SS	3/8	M20x1.5	45.1	14	16.8	7.1	17.5	25.4	25
A8-MRM16*1.5-U-SS	1/2	M16x1.5	44	12	22.8	9	22.2	22.2	21
A8-MRM18*1.5-U-SS	1/2	M18x1.5	44	12	22.9	10	22.2	23.8	23
A8-MRM20*1.5-U-SS	1/2	M20x1.5	47.9	14	22.9	10.4	22.2	25.4	25
A8-MRM22*1.5-U-SS	1/2	M22x1.5	48.5	14	22.9	10.4	22.2	27	27

型号	接口类型和尺寸		尺寸 mm						
	端口1 卡套 mm	端口2 公制螺纹 M	L	B	C	E	G	F	D
A6M-MRM8*1-U-SS	6	M8x1	33.3	8	15.3	3	14	14	12
A6M-MRM10*1-U-SS	6	M10x1	33.3	8	15.3	4	14	14	14
A6M-MRM12*1.5-U-SS	6	M12x1.5	38.2	12	15.3	4.8	14	18	17
A6M-MRM14*1.5-U-SS	6	M14x1.5	39.7	12	15.3	4.8	14	22	19
A8M-MRM8*1-U-SS	8	M8x1	34.1	8	16.2	3	16	14	12
A8M-MRM10*1-U-SS	8	M10x1	34.1	8	16.2	5	16	14	14
A8M-MRM12*1.5-U-SS	8	M12x1.5	40.4	12	16.2	6	16	18	17
A8M-MRM14*1.5-U-SS	8	M14x1.5	40.4	12	16.2	6.4	16	19	19
A10M-MRM12*1.5-U-SS	10	M12x1.5	40.7	12	17.2	6	19	18	17
A10M-MRM14*1.5-U-SS	10	M14x1.5	39.5	12	17.2	7.9	19	19	19
A12M-MRM16*1.5-U-SS	12	M16x1.5	45.5	12	22.8	9	22	22	21
A12M-MRM20*1.5-U-SS	12	M20x1.5	48	14	22.8	9.5	22	25	25
A12M-MRM22*1.5-U-SS	12	M22x1.5	47.5	14	22.8	9.5	22	27	27
A14M-MRM14*1.5-U-SS	14	M14x1.5	44.9	12	24.4	8	25	24	19
A14M-MRM20*1.5-U-SS	14	M20x1.5	48	14	24.4	11.1	25	27	25
A16M-MRM20*1.5-U-SS	16	M20x1.5	48	14	24.4	12	25	25	25
A18M-MRM20*1.5-U-SS	18	M20x1.5	48.5	14	24.4	12	30	27	25
A20M-MRM20*1.5-U-SS	20	M20x1.5	50	14	26	12	32	30	25
A22M-MRM24*1.5-U-SS	22	M24x1.5	50.5	14	26	15	32	30	28.8
A25M-MRM27*2-U-SS	25	M27x2	57.5	16	31.3	16.8	38	35	32

卡套-公制外螺纹直通 (根部O型圈密封)

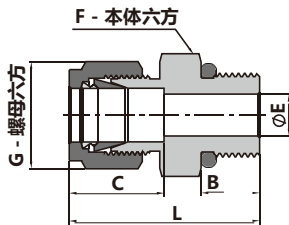

型号	接口类型和尺寸		尺寸 mm						
	端口1 卡套 in.	端口2 公制螺纹 M	L	B	C	E	G	F	
A4-MOM14*1.5-U-SS	1/4	M14X1.5	35.2	11	15.2	4.8	14.3	19.1	
A6-MOM14*1.5-U-SS	3/8	M14X1.5	36.7	11	16.8	7.1	17.5	19.1	
A6-MOM20*1.5-U-SS	3/8	M20X1.5	41.2	14	16.8	7.1	17.5	27	
A8-MOM14*1.5-U-SS	1/2	M14X1.5	40.2	11	22.9	7.5	22.2	20.6	
A8-MOM20*1.5-U-SS	1/2	M20X1.5	44	14	22.9	10.4	22.2	27	

型号	接口类型和尺寸		尺寸 mm						
	端口1 卡套 mm	端口2 公制螺纹 M	L	B	C	E	G	F	
A6M-MOM14*1.5-U-SS	6	M14x1.5	38.7	11	15.3	4.8	14	19	
A10M-MOM14*1.5-U-SS	10	M14x1.5	40	11	17.2	7.5	19	19	
A10M-MOM20*1.5-U-SS	10	M20x1.5	41.2	14	17.2	7.9	19	27	
A12M-MOM14*1.5-U-SS	12	M14x1.5	40.2	11	22.8	7.5	22	22	
A12M-MOM20*1.5-U-SS	12	M20x1.5	47.2	14	22.8	9.5	22	27	

英制卡套-**SAE/MS**螺纹直通

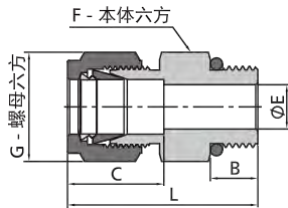

型号	接口类型和尺寸		尺寸 mm					
	端口1 卡套 in.	端口2 SAE/MS外螺纹 in.	L	B	C	E	G	F
A1-MUNF5/16-24-U-SS	1/16	5/16-24	23.4	7.6	8.6	1.3	7.9	11.1
A2-MUNF5/16-24-U-SS	1/8	5/16-24	30	7.6	12.7	2.3	11.1	11.1
A2-MUNF7/16-20-U-SS	1/8	7/16-20	31.5	9.1	12.7	2.3	11.1	14.3
A2-MUNF9/16-18-U-SS	1/8	9/16-18	33.3	9.9	12.7	2.3	11.1	17.5
A3-MUNF3/8-24-U-SS	3/16	3/8-24	30.5	7.6	13.7	3	12.7	12.7
A4-MUNF5/16-24-U-SS	1/4	5/16-24	32.3	7.6	15.2	3	14.3	12.7
A4-MUNF7/16-20-U-SS	1/4	7/16-20	34	9.1	15.2	4.8	14.3	14.3
A4-MUNF9/16-18-U-SS	1/4	9/16-18	35.6	9.9	15.2	4.8	14.3	17.5
A4-MUNF3/4-16-U-SS	1/4	3/4-16	37.6	11.2	15.2	4.8	14.3	22.2
A4-MUNF7/8-14-U-SS	1/4	7/8-14	40.6	12.7	15.2	4.8	14.3	25.4
A5-MUNF1/2-20-U-SS	5/16	1/2-20	34.8	9.1	16.3	6.4	15.9	15.9
A6-MUNF7/16-20-U-SS	3/8	7/16-20	35.6	9.1	16.8	5.1	17.5	15.9
A6-MUNF9/16-18-U-SS	3/8	9/16-18	37.1	9.9	16.8	7.1	17.5	17.5
A6-MUNF3/4-16-U-SS	3/8	3/4-16	39.1	11.2	16.8	7.1	17.5	22.2
A6-MUNF7/8-14-U-SS	3/8	7/8-14	42.2	12.7	16.8	7.1	17.5	25.4
A8-MUNF9/16-18-U-SS	1/2	9/16-18	39.1	9.9	22.9	7.1	22.2	20.6
A8-MUNF3/4-16-U-SS	1/2	3/4-16	41.9	11.2	22.9	10.4	22.2	22.2
A8-MUNF7/8-14-U-SS	1/2	7/8-14	45	12.7	22.9	10.4	22.2	25.4
A8-MUNF11/16-12-U-SS	1/2	11/16-12	49	15	22.9	10.4	22.2	31.8
A10-MUNF3/4-16-U-SS	5/8	3/4-16	41.9	11.2	24.4	10.7	25.4	23.8
A10-MUNF7/8-14-U-SS	5/8	7/8-14	45.2	12.7	24.4	12.7	25.4	25.4
A12-MUNF3/4-16-U-SS	3/4	3/4-16	46	11.2	24.4	10.7	28.6	27
A12-MUNF11/16-12-U-SS	3/4	11/16-12	49	15	24.4	15.7	28.6	31.8
A12-MUNF15/16-12-U-SS	3/4	15/16-12	49.8	15	24.4	16	28.6	38.1
A14-MUNF3/16-12-U-SS	7/8	3/16-12	49	15	25.9	18.3	31.8	34.9
A16-MUNF11/16-12-U-SS	1	11/16-12	53.3	15	31.2	16.8	38.1	34.9
A16-MUNF15/16-12-U-SS	1	15/16-12	54.4	15	31.2	22.4	38.1	38.1
A20-MUNF15/8-12-U-SS	11/4	15/8-12	68.3	15	41.1	27.7	47.6	47.6
A24-MUNF17/8-12-U-SS	11/2	17/8-12	77.7	15	50	34	57.2	54

公制卡套-**SAE/MS**螺纹直通

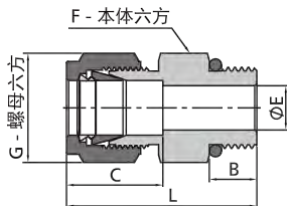

型号	接口类型和尺寸		尺寸 mm					
	端口1 卡套 mm	端口2 SAE/MS外螺纹 in.	L	B	C	E	G	F
A6M-MUNF9/16-18-U-SS	6	9/16-18	35.6	9.9	15.3	4.8	14	18
A10M-MUNF9/16-18-U-SS	10	9/16-18	37.3	9.9	17.2	7.1	19	18
A10M-MUNF3/4-16-U-SS	10	3/4-16	39.4	11.2	17.2	7.9	19	22
A12M-MUNF7/16-20-U-SS	12	7/16-20	40.6	9.1	22.8	5.2	22	22
A12M-MUNF9/16-18-U-SS	12	9/16-18	39.9	9.9	22.8	7.1	22	22

卡套-**SAE/MS外螺纹直通 (外螺纹根部O型圈密封)**

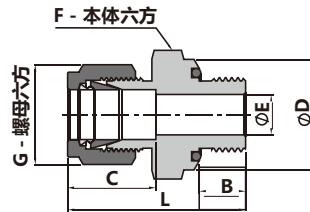

型号	接口类型和尺寸		尺寸 mm						
	端口1 卡套 in.	端口2 SAE/MS 直螺纹 in.	L	B	C	E	G	F	D
A1-MOUNF5/16-24-U-SS	1/16	5/16-24	26.7	8.6	8.6	1.3	7.9	14.3	14
A2-MOUNF5/16-24-U-SS	1/8	5/16-24	32.8	8.6	12.7	2.3	11.1	14.3	14
A3-MOUNF3/8-24-U-SS	3/16	3/8-24	34.3	9.7	13.7	3	12.7	15.9	15.7
A4-MOUNF7/16-20-U-SS	1/4	7/16-20	38.4	10.4	15.2	4.8	14.3	19.1	18.8
A5-MOUNF1/2-20-U-SS	5/16	1/2-20	40.6	11.2	16.3	6.4	15.9	22.2	21.8
A6-MOUNF9/16-18-U-SS	3/8	9/16-18	42.4	11.9	16.8	7.1	17.5	23.8	23.6
A8-MOUNF3/4-16-U-SS	1/2	3/4-16	46	11.9	22.9	10.4	22.2	28.6	28.4
A12-MOUNF11/16-12-U-SS	3/4	11/16-12	52.3	14.2	24.4	15.7	28.6	38.1	37.8
A16-MOUNF15/16-12-U-SS	1	15/16-12	58.2	14.2	31.2	22.4	38.1	44.5	44.2

卡套-**37°扩口外螺纹直通**

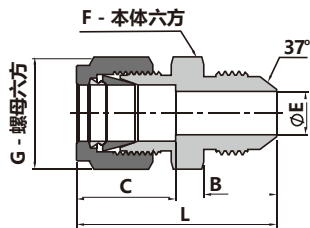

型号	接口类型和尺寸		尺寸 mm						
	端口1 卡套 in.	端口2 37°扩口 in.	L	B	C	E	G	F	
A1-MAN2-U-SS	1/16	1/8	27.2	11.4	8.6	1.3	7.9	11.1	
A2-MAN2-U-SS	1/8	1/8	32.3	11.4	12.7	1.5	11.1	11.1	
A2-MAN4-U-SS	1/8	1/4	35.1	14	12.7	2.3	11.1	12.7	
A3-MAN3-U-SS	3/16	3/16	33.5	12.2	13.7	3	12.7	11.1	
A4-MAN4-U-SS	1/4	1/4	37.6	14	15.2	4.3	14.3	12.7	
A5-MAN5-U-SS	5/16	5/16	38.4	14	16.2	5.8	15.9	14.3	
A6-MAN4-U-SS	3/8	1/4	39.6	14	16.8	4.3	17.5	15.9	
A6-MAN6-U-SS	3/8	3/8	39.6	14.1	16.8	7.1	17.5	15.9	
A8-MAN8-U-SS	1/2	1/2	46	16.7	22.8	9.9	22.2	20.6	
A10-MAN10-U-SS	5/8	5/8	49	19.3	24.5	12.3	25.4	23.8	
A12-MAN12-U-SS	3/4	3/4	53.3	21.9	24.4	15.5	28.6	28.6	
A16-MAN16-U-SS	1	1	61.5	23.1	31.2	21.3	38.1	34.9	

卡套穿板-37°扩口外螺纹直通

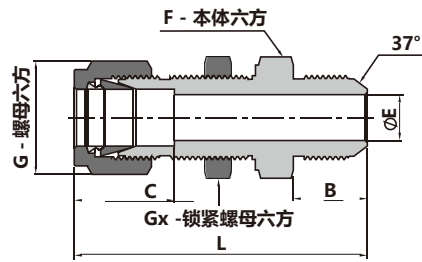

型号	接口类型和尺寸		尺寸 mm								面板孔尺寸	最大面板厚度
	端口1 卡套 in.	端口2 37°扩口接头 in.	L	B	C	E	G	F	GX			
BA2-MAN2-U-SS	1/8	1/8	48.5	11.4	12.7	1.5	11.1	12.7	12.7	8.3	12.7	
BA2-MAN4-U-SS	1/8	1/4	51.8	14	12.7	2.3	11.1	15.9	12.7	8.3	12.7	
BA3-MAN3-U-SS	3/16	3/16	50.3	12.2	13.7	3	12.7	14.3	14.3	9.9	12.7	
BA4-MAN4-U-SS	1/4	1/4	53.8	14	15.2	4.3	14.3	15.9	15.9	11.5	10.2	
BA5-MAN5-U-SS	5/16	5/16	56.1	14	16.2	5.8	15.9	17.5	17.5	13.1	14.3	
BA6-MAN4-U-SS	3/8	1/4	57.2	14	16.8	4.3	17.5	19.1	19.1	14.7	11.2	
BA6-MAN6-U-SS	3/8	3/8	57.2	14.2	16.8	7.1	17.5	19.1	19.1	14.7	11.2	
BA8-MAN8-U-SS	1/2	1/2	65.8	16.8	22.8	9.9	22.2	23.8	23.8	19.4	12.7	
BA10-MAN10-U-SS	5/8	5/8	69.6	19.3	24.4	12.3	25.4	27	27	22.6	15.1	
BA12-MAN12-U-SS	3/4	3/4	79	21.8	24.4	15.5	28.6	30.2	30.2	25.8	16.8	
BA16-MAN16-U-SS	1	1	92.5	23.1	31.2	21.3	38.1	41.3	41.3	33.7	19.1	

卡套-NPT内螺纹直通

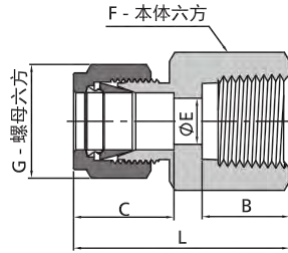

注: RC螺纹尺寸与NPT螺纹相同, 对应型号中只需把F变为FRC, 如A6M-FRC4-U-SS

型号	接口类型和尺寸		尺寸 mm					
	端口1 卡套 in.	端口2 FNPT in.	L	B	C	E	G	F
A1-F1-U-SS	1/16	1/16	23.6	9.9	8.6	1.3	7.9	11.1
A1-F2-U-SS	1/16	1/8	24.4	10.4	8.6	1.3	7.9	14.3
A2-F2-U-SS	1/8	1/8	28.7	10.4	12.7	2.3	11.1	14.3
A2-F4-U-SS	1/8	1/4	33.5	15	12.7	2.3	11.1	19.1
A3-F2-U-SS	3/16	1/8	29.7	10.4	13.7	3	12.7	14.3
A4-F2-U-SS	1/4	1/8	31.2	10.4	15.2	4.8	14.3	14.3
A4-F4-U-SS	1/4	1/4	35.8	15	15.2	4.8	14.3	19.1
A4-F6-U-SS	1/4	3/8	37.6	15	15.2	4.8	14.3	22.2
A4-F8-U-SS	1/4	1/2	42.4	19.8	15.2	4.8	14.3	27
A5-F2-U-SS	5/16	1/8	32	10.4	16.3	6.4	15.9	14.3
A5-F4-U-SS	5/16	1/4	36.8	15	16.3	6.4	15.9	19.1
A6-F2-U-SS	3/8	1/8	32.8	10.4	16.8	7.1	17.5	15.9
A6-F4-U-SS	3/8	1/4	37.6	15	16.8	7.1	17.5	19.1
A6-F6-U-SS	3/8	3/8	39.1	15	16.8	7.1	17.5	22.2
A6-F8-U-SS	3/8	1/2	43.9	19.8	16.8	7.1	17.5	27
A6-F12-U-SS	3/8	3/4	47.8	20.6	16.8	7.1	17.5	33.3
A8-F4-U-SS	1/2	1/4	40.4	15	22.9	10.4	22.2	20.6
A8-F6-U-SS	1/2	3/8	41.9	15	22.9	10.4	22.2	22.2
A8-F8-U-SS	1/2	1/2	46.7	19.8	22.9	10.4	22.2	27
A8-F12-U-SS	1/2	3/4	48.3	20.6	22.9	10.4	22.2	33.3
A5-F6-U-SS	5/8	3/8	41.9	15	24.4	12.7	25.4	23.8
A5-F8-U-SS	5/8	1/2	46.7	19.8	24.4	12.7	25.4	27
A12-F8-U-SS	3/4	1/2	46.7	19.8	24.4	15.7	28.6	27
A12-F12-U-SS	3/4	3/4	48.3	20.6	24.4	15.7	28.6	33.3
A14-F12-U-SS	7/8	3/4	49.8	20.6	25.9	18.3	31.8	33.3
A16-F12-U-SS	1	3/4	53.3	20.6	31.2	22.4	38.1	34.9
A16-F16-U-SS	1	1	62.2	25.4	31.2	22.4	38.1	41.3
A20-F20-U-SS	11/4	11/4	74.7	25.4	41.1	27.7	47.6	54
A24-F24-U-SS	11/2	11/2	83.8	27.7	50	34	57.2	60.3

型号	接口类型和尺寸		尺寸 mm					
	端口1 卡套 mm	端口2 FNPT in.	L	B	C	E	G	F
A3M-F2-U-SS	3	1/8	28.7	10.4	12.9	2.4	12	14
A3M-F4-U-SS	3	1/4	33.5	15	12.9	2.4	12	19
A4M-F2-U-SS	4	1/8	29.7	10.4	13.7	2.4	12	14
A6M-F2-U-SS	6	1/8	31.3	10.4	15.3	4.8	14	14
A6M-F4-U-SS	6	1/4	35.8	15	15.3	4.8	14	19
A6M-F6-U-SS	6	3/8	37.7	15	15.3	4.8	14	22
A6M-F8-U-SS	6	1/2	42.5	19.8	15.3	4.8	14	27
A8M-F2-U-SS	8	1/8	32.1	10.4	16.2	6.4	16	15
A8M-F4-U-SS	8	1/4	37	15	16.2	6.4	16	19
A8M-F6-U-SS	8	3/8	38.5	15	16.2	6.4	16	22
A8M-F8-U-SS	8	1/2	43.3	19.8	16.2	6.4	16	27
A10M-F2-U-SS	10	1/8	33	10.4	17.2	7.9	19	18
A10M-F4-U-SS	10	1/4	37.8	15	17.2	7.9	19	19
A10M-F6-U-SS	10	3/8	39.4	15	17.2	7.9	19	22
A10M-F8-U-SS	10	1/2	44.2	19.8	17.2	7.9	19	27
A12M-F4-U-SS	12	1/4	40.3	15	22.8	9.5	22	22
A12M-F6-U-SS	12	3/8	41.9	15	22.8	9.5	22	22
A12M-F8-U-SS	12	1/2	46.7	19.8	22.8	9.5	22	27
A12M-F12-U-SS	12	3/4	49.1	20.6	22.8	9.5	22	35
A14M-F12-U-SS	14	3/4	49.7	20.6	24.4	11.1	25	35
A15M-F8-U-SS	15	1/2	46.7	19.8	24.4	11.9	25	27
A16M-F6-U-SS	16	3/8	41.9	15	24.4	12.7	25	27
A16M-F8-U-SS	16	1/2	46.9	19.8	24.4	12.7	25	27
A20M-F8-U-SS	20	1/2	47.9	19.8	26	15.9	32	30
A20M-F12-U-SS	20	3/4	49.7	20.6	26	15.9	32	35
A22M-F12-U-SS	22	3/4	49.7	20.6	26	18.3	32	35
A22M-F16-U-SS	22	1	57.9	25.4	26	18.3	32	41
A25M-F12-U-SS	25	3/4	53.4	20.6	31.3	21.8	38	35
A25M-F16-U-SS	25	1	62.3	25.4	31.3	21.8	38	41

卡套穿板-NPT内螺纹直通

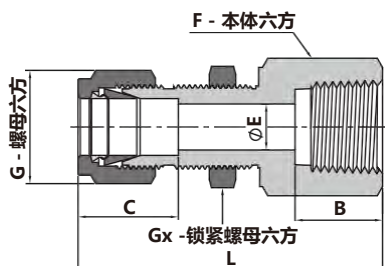

注：RC螺纹尺寸与NPT螺纹相同，对应型号中只需把F变为FRC，如BA6M-FRC4-U-SS

型号	接口类型和尺寸		尺寸mm								
	端口1 卡套 in.	端口2 FNPT in.	L	B	C	E	G	F	Gx	面板 孔尺寸	最大 面板 厚度
BA1-F1-U-SS	1/16	1/16	30.2	9.9	8.6	1.3	7.9	11.1	7.9	5.2	3.2
BA1-F2-U-SS	1/16	1/8	30.7	10.4	8.6	1.3	7.9	14.3	7.9	5.2	3.2
BA2-F2-U-SS	1/8	1/8	44.7	10.4	12.7	2.3	11.1	14.3	12.7	8.3	12.7
BA2-F4-U-SS	1/8	1/4	49.6	15	12.7	2.3	11.1	19.1	12.7	8.3	12.7
BA3-F2-U-SS	3/16	1/8	45.5	10.4	13.7	3	12.7	14.3	14.3	9.9	12.7
BA4-F2-U-SS	1/4	1/8	47	10.4	15.2	4.8	14.3	15.9	15.9	11.5	10.2
BA4-F4-U-SS	1/4	1/4	51.8	15	15.2	4.8	14.3	19.1	15.9	11.5	10.2
BA4-F6-U-SS	1/4	3/8	53.3	15	15.2	4.8	14.3	22.2	15.9	11.5	10.2
BA4-F8-U-SS	1/4	1/2	58.2	19.8	15.2	4.8	14.3	27	15.9	11.5	10.2
BA5-F2-U-SS	5/16	1/8	49.8	10.4	16.3	6.4	15.9	17.5	17.5	13.1	11.2
BA5-F4-U-SS	5/16	1/4	60.5	15	16.3	6.4	15.9	19.1	17.5	13.1	11.2
BA6-F2-U-SS	3/8	1/8	50.3	10.4	16.8	7.1	17.5	19.1	19.1	14.7	11.2
BA6-F4-U-SS	3/8	1/4	55.1	15	16.8	7.1	17.5	19.1	19.1	14.7	11.2
BA6-F6-U-SS	3/8	3/8	56.6	15	16.8	7.1	17.5	22.2	19.1	14.7	11.2
BA6-F8-U-SS	3/8	1/2	61.5	19.8	16.8	7.1	17.5	27	19.1	14.7	11.2
BA6-F12-U-SS	3/8	3/4	65.3	20.6	16.8	7.1	17.5	33.3	19.1	14.7	11.2
BA8-F4-U-SS	1/2	1/4	60.2	15	22.9	10.4	22.2	23.8	23.8	19.4	12.7
BA8-F6-U-SS	1/2	3/8	61.7	15	22.9	10.4	22.2	23.8	23.8	19.4	12.7
BA8-F8-U-SS	1/2	1/2	66.5	19.8	22.9	10.4	22.2	27	23.8	19.4	12.7
BA8-F12-U-SS	1/2	3/4	68.1	20.6	22.9	10.4	22.2	33.3	23.8	19.4	12.7
BA10-F6-U-SS	5/8	3/8	62.5	15	24.4	12.7	25.4	27	27	22.6	15.1
BA10-F8-U-SS	5/8	1/2	67.3	19.8	24.4	12.7	25.4	27	27	22.6	15.1
BA12-F8-U-SS	3/4	1/2	72.2	19.8	24.4	15.7	28.6	30.2	30.2	25.8	19.8
BA12-F12-U-SS	3/4	3/4	73.7	20.6	24.4	15.7	28.6	33.3	30.2	25.8	19.8
BA14-F12-U-SS	7/8	3/4	80.8	20.6	25.9	18.3	31.8	33.3	33.3	29	23.8
BA16-F12-U-SS	1	3/4	84.7	20.6	31.2	22.4	38.1	41.3	41.3	33.7	23.8
BA16-F16-U-SS	1	1	93.5	25.4	31.2	22.4	38.1	41.3	41.3	33.7	23.8

型号	接口类型和尺寸		尺寸mm								
	端口1 卡套 mm	端口2 FNPT in.	L	B	C	E	G	F	Gx	面板 孔尺寸	最大 面板 厚度
BA6M-F2-U-SS	6	1/8	47.2	10.4	15.3	4.8	14	16	16	11.5	10.2
BA6M-F4-U-SS	6	1/4	51.8	15	15.3	4.8	14	19	16	11.5	10.2
BA8M-F2-U-SS	8	1/8	49.6	10.4	16.2	6.4	16	18	18	13.1	11.2
BA10M-F4-U-SS	10	1/4	55.2	15	17.2	7.9	19	22	22	16.3	11.2
BA12M-F6-U-SS	12	3/8	62.9	15	22.8	9.5	22	24	24	19.5	12.7
BA12M-F8-U-SS	12	1/2	66.5	19.8	22.8	9.5	22	27	24	19.5	12.7

英制卡套-ISO平行内螺纹直通 (内螺纹底部金属垫片密封)

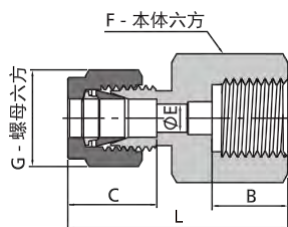

型号	接口类型和尺寸		尺寸 mm					
	端口1 卡套 in.	端口2 ISO平行内螺纹 in.	L	B	C	E	G	F
A2-FG4-U-SS	1/8	1/4	35.3	12.9	12.7	2.3	11.1	19.1
A2-FG6-U-SS	1/8	3/8	38.7	14.2	12.7	2.3	11.1	23.8
A4-FG4-U-SS	1/4	1/4	37.6	12.9	15.2	4.8	14.3	19.1
A4-FG6-U-SS	1/4	3/8	37.6	14.2	15.2	4.8	14.3	23.8
A4-FG8-U-SS	1/4	1/2	43.4	18.8	15.2	4.8	14.3	27
A5-FG4-U-SS	5/16	1/4	38.4	12.9	16.3	5.6	15.9	19.1
A5-FG6-U-SS	5/16	3/8	36.9	14.2	16.3	6.4	15.9	23.8
A5-FG8-U-SS	5/16	1/2	40.9	18.8	16.3	7.1	15.9	27
A6-FG4-U-SS	3/8	1/4	39.1	12.9	16.8	5.6	17.5	19.1
A6-FG6-U-SS	3/8	3/8	38.6	14.2	16.8	6.4	17.5	23.8
A6-FG8-U-SS	3/8	1/2	41.9	18.8	16.8	7.1	17.5	27
A8-FG4-U-SS	1/2	1/4	41.9	12.9	22.9	5.6	22.2	22.2
A8-FG6-U-SS	1/2	3/8	44.5	14.2	22.9	6.4	22.2	23.8
A8-FG8-U-SS	1/2	1/2	48.3	18.8	22.9	7.1	22.2	27

公制卡套-ISO平行内螺纹直通 (内螺纹底部金属垫片密封)

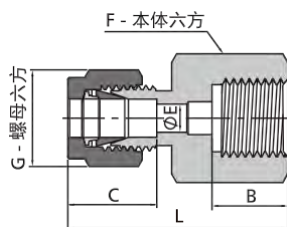

型号	接口类型和尺寸		尺寸 mm					
	端口1 卡套 mm	端口2 ISO平行内螺纹 in.	L	B	C	E	G	F
A3M-FG4-U-SS	3	1/4	35.3	12.9	12.9	2.4	12	19
A6M-FG4-U-SS	6	1/4	37.6	12.9	15.3	4.8	14	19
A6M-FG6-U-SS	6	3/8	37.6	14.2	15.3	4.8	14	24
A6M-FG8-U-SS	6	1/2	43.5	18.8	15.3	4.8	14	27
A8M-FG4-U-SS	8	1/4	38.5	12.9	16.2	5.5	16	19
A8M-FG6-U-SS	8	3/8	36.2	14.2	16.2	6.4	16	24
A8M-FG8-U-SS	8	1/2	41	18.8	16.2	6.4	16	27
A10M-FG4-U-SS	10	1/4	39.4	12.9	17.2	5.5	19	19
A10M-FG6-U-SS	10	3/8	38.8	14.2	17.2	6.4	19	24
A10M-FG8-U-SS	10	1/2	42.1	18.8	17.2	7.9	19	27
A12M-FG4-U-SS	12	1/4	41.9	12.9	22.8	5.5	22	22
A12M-FG6-U-SS	12	3/8	44.4	14.2	22.8	6.4	22	24
A12M-FG8-U-SS	12	1/2	48.2	18.8	22.8	7.1	22	27
A20M-FG8-U-SS	20	1/2	54.3	18.8	26	7.1	32	30
A22M-FG8-U-SS	22	1/2	54.3	18.8	26	7.1	32	30

英制卡套-公制内螺纹直通

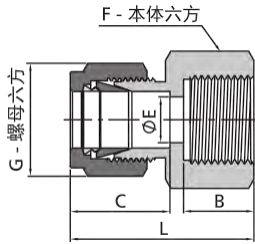

型号	接口类型和尺寸		尺寸 mm					
	端口1 卡套 in.	端口2 公制内螺纹 M	L	B	C	E	G	F
A2-FM16*1.5-U-SS	1/8	M16x1.5	33.3	14	12.7	2.3	11.1	22.2
A2-FM18*1.5-U-SS	1/8	M18x1.5	34.3	15	12.7	2.3	11.1	25.4
A2-FM20*1.5-U-SS	1/8	M20x1.5	35.3	16	12.7	2.3	11.1	27
A4-FM16*1.5-U-SS	1/4	M16x1.5	35.8	14	15.2	4.8	14.3	22.2
A4-FM18*1.5-U-SS	1/4	M18x1.5	36.8	15	15.2	4.8	14.3	25.4
A4-FM20*1.5-U-SS	1/4	M20x1.5	37.8	16	15.2	4.8	14.3	27
A6-FM14*1.5-U-SS	3/8	M14x1.5	37.1	13	16.8	7.1	17.5	19.1
A6-FM16*1.5-U-SS	3/8	M16x1.5	37.5	14	16.8	7.1	17.5	22.2
A6-FM18*1.5-U-SS	3/8	M18x1.5	38.5	15	16.8	7.1	17.5	25.4
A6-FM20*1.5-U-SS	3/8	M20x1.5	39.5	16	16.8	7.1	17.5	27
A8-FM16*1.5-U-SS	1/2	M16x1.5	41.4	14	22.9	8.4	22.2	22.2
A8-FM18*1.5-U-SS	1/2	M18x1.5	42.4	15	22.9	9.6	22.2	25.4
A8-FM20*1.5-U-SS	1/2	M20x1.5	43.4	16	22.9	10.4	22.2	27
A8-FM22*1.5-U-SS	1/2	M22x1.5	41.9	16	22.9	9.7	22.2	27

公制卡套-公制内螺纹直通

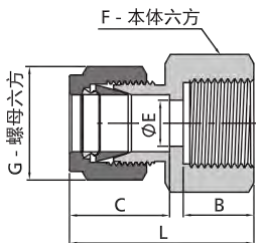

型号	接口类型和尺寸		尺寸 mm					
	端口1 卡套 mm	端口2 公制内螺纹 M	L	B	C	E	G	F
A6M-FM10*1-U-SS	6	M10x1	32.7	11	15.3	4.7	14	16
A6M-FM14*1.5-U-SS	6	M14x1.5	36.1	13	15.3	4.8	14	19
A6M-FM20*1.5-U-SS	6	M20x1.5	37.7	16	15.3	4.8	14	27
A8M-FM8*1-U-SS	8	M8x1	31.6	9	16.2	3	16	14
A8M-FM10*1-U-SS	8	M10x1	33.6	11	16.2	4	16	16
A8M-FM14*1.5-U-SS	8	M14x1.5	35.6	13	16.2	6.4	16	19
A8M-FM20*1.5-U-SS	8	M20x1.5	38.6	16	16.2	6.4	16	27
A10M-FM16*1.5-U-SS	10	M16x1.5	38.1	14	17.2	7.9	19	22
A12M-FM20*1.5-U-SS	12	M20x1.5	44.9	16	22.8	9.5	22	27
A14M-FM10*1-U-SS	14	M10x1	42.5	11	24.4	4	25	24
A14M-FM20*1.5-U-SS	14	M20x1.5	44.9	16	24.4	10.8	25	27
A14M-FM22*1.5-U-SS	14	M22x1.5	45.9	17	24.4	11.1	25	27
A16M-FM20*1.5-U-SS	16	M20x1.5	44.9	16	24.4	10.8	25	27
A20M-FM20*1.5-U-SS	20	M20x1.5	46.5	16	26	10.8	32	30
A25M-FM27*2-U-SS	25	M27x2	54.4	18	31.3	16.1	38	35

钢瓶接头

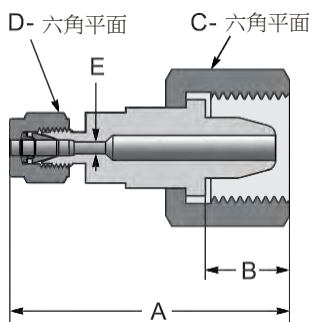

型号	接口类型和尺寸		尺寸 mm				
	端口1 卡套 mm	端口2 气 瓶外螺纹 in.	A	B	C	D	E
A3M-FGPG5/8-U-SS	3	G5/8	53.1	18.8	30	12	2.4
A3M-FGPG5/8-LH-U-SS	3	G5/8反扣	53.1	18.8	30	12	2.4
A3M-FGPW21.8-14-U-SS	3	W21.8-14	53.1	16.8	28	12	2.4
A3M-FGPW21.8-14-LH-U-SS	3	W21.8-14 反扣	53.1	16.8	28	12	2.4
A6M-FGPG5/8-U-SS	6	G5/8	63.5	18.8	30	14	4.8
A6M-FGPG5/8-LH-U-SS	6	G5/8反扣	63.5	18.8	30	14	4.8
A6M-FGPW21.8-14-U-SS	6	W21.8-14	63.5	16.8	28	14	4.8
A6M-FGPW21.8-14-LH-U-SS	6	W21.8-14 反扣	63.5	16.8	28	14	4.8
A8M-FGPG5/8-U-SS	8	G5/8	63.5	18.8	30	16	5.0
A8M-FGPG5/8-LH-U-SS	8	G5/8反扣	63.5	18.8	30	16	5.0
A8M-FGPW21.8-14-U-SS	8	W21.8-14	63.5	16.8	28	16	5.0

卡套-仪表管承插焊 (Tube Socket Weld)

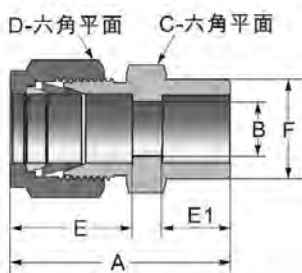

注意: A和E为手紧尺寸

型号	接口类型和尺寸	
	端口1卡套 in.	端口2 TUBE承插焊 in.
A2-TSW2-U-SS	1/8	1/8
A4-TSW4-U-SS	1/4	1/4
A6-TSW6-U-SS	3/8	3/8
A8-TSW8-U-SS	1/2	1/2
A12-TSW12-U-SS	3/4	3/4
A16-TSW16-U-SS	1	1

英制卡套-英制公称管对焊

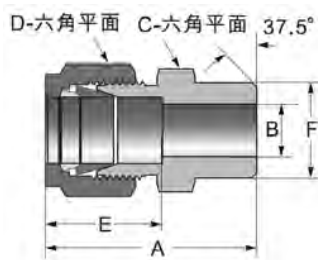

注意: A和E为手紧尺寸

型号	接口类型和尺寸	
	端口1卡套 in.	端口2 PIPE 对焊 in.
A2-PBW2-U-SS	1/8	1/8
A4-PBW4-U-SS	1/4	1/4
A6-PBW6-U-SS	3/8	3/8
A8-PBW8-U-SS	1/2	1/2
A12-PBW12-U-SS	3/4	3/4
A16-PBW16-U-SS	1	1
A20-PBW20-U-SS	1 1/4	1 1/4
A24-PBW24-U-SS	1 1/2	1 1/2

公制卡套-英制公称管对焊

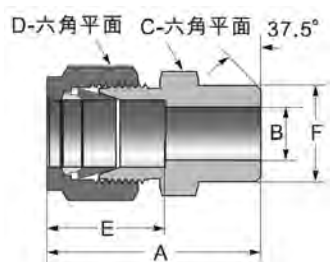

注意: A和E为手紧尺寸

型号	接口类型和尺寸	
	端口1卡套 mm	端口2 PIPE 对焊 in.
A3M-PBW2-U-SS	3	1/8
A4M-PBW2-U-SS	4	1/8
A6M-PBW2-U-SS	6	1/8
A6M-PBW4-U-SS	6	1/4
A8M-PBW2-U-SS	8	1/8
A8M-PBW4-U-SS	8	1/4
A8M-PBW8-U-SS	8	1/2
A10M-PBW4-U-SS	10	1/4
A10M-PBW6-U-SS	10	3/8
A10M-PBW8-U-SS	10	1/2
A12M-PBW4-U-SS	12	1/4
A12M-PBW6-U-SS	12	3/8
A12M-PBW8-U-SS	12	1/2
A12M-PBW12-U-SS	12	3/4
A14M-PBW6-U-SS	14	3/8
A15M-PBW8-U-SS	15	1/2
A16M-PBW8-U-SS	16	1/2
A18M-PBW8-U-SS	18	1/2
A30M-PBW20-U-SS	30	1 1/4
A32M-PBW20-U-SS	32	1 1/4
A38M-PBW24-U-SS	38	1 1/2

卡套-卡套管直通

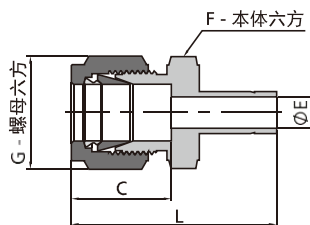

型号	接口类型和尺寸		尺寸 mm				
	端口1 卡套 in.	端口2 卡套管 in.	L	C	G	F	E
A1-TA2-U-SS	1/16	1/8	29.2	8.6	7.9	7.9	1.3
A1-TA3-U-SS	1/16	3/16	30	8.6	7.9	7.9	1.3
A1-TA4-U-SS	1/16	1/4	31.5	8.6	7.9	7.9	1.3
A2-TA1-U-SS	1/8	1/16	29	12.7	11.1	11.1	0.8
A2-TA2-U-SS	1/8	1/8	33.5	12.7	11.1	11.1	2
A2-TA3-U-SS	1/8	3/16	34.3	12.7	11.1	11.1	2.3
A2-TA4-U-SS	1/8	1/4	36.1	12.7	11.1	11.1	2.3
A2-TA6-U-SS	1/8	3/8	37.6	12.7	11.1	11.1	2.3
A2-TA8-U-SS	1/8	1/2	44.2	12.7	11.1	14.3	2.3
A3-TA2-U-SS	3/16	1/8	34.8	13.7	12.7	11.1	2
A3-TA4-U-SS	3/16	1/4	37.1	13.7	12.7	11.1	3
A4-TA2-U-SS	1/4	1/8	36.8	15.2	14.3	12.7	2
A4-TA3-U-SS	1/4	3/16	37.6	15.2	14.3	12.7	3
A4-TA4-U-SS	1/4	1/4	39.1	15.2	14.3	12.7	4.3
A4-TA5-U-SS	1/4	5/16	39.9	15.2	14.3	12.7	4.8
A4-TA6-U-SS	1/4	3/8	40.6	15.2	14.3	12.7	4.8
A4-TA8-U-SS	1/4	1/2	46.2	15.2	14.3	14.3	4.8
A4-TA10-U-SS	1/4	5/8	48	15.2	14.3	17.5	4.8
A4-TA12-U-SS	1/4	3/4	47.8	15.2	14.3	20.6	4.8
A5-TA6-U-SS	5/16	3/8	41.9	16.3	15.9	14.3	6.4
A5-TA8-U-SS	5/16	1/2	47.5	16.3	15.9	14.3	6.4
A6-TA4-U-SS	3/8	1/4	41.4	16.8	17.5	15.9	4.3
A6-TA6-U-SS	3/8	3/8	43.2	16.8	17.5	15.9	6.9
A6-TA8-U-SS	3/8	1/2	48.5	16.8	17.5	15.9	7.1
A6-TA10-U-SS	3/8	5/8	50.3	16.8	17.5	17.5	7.1
A6-TA12-U-SS	3/8	3/4	50.3	16.8	17.5	20.6	7.1
A8-TA4-U-SS	1/2	1/4	45	22.9	22.2	20.6	4.3
A8-TA6-U-SS	1/2	3/8	46.7	22.9	22.2	20.6	6.9
A8-TA8-U-SS	1/2	1/2	52.3	22.9	22.2	20.6	9.4
A8-TA10-U-SS	1/2	5/8	53.8	22.9	22.2	20.6	10.4
A8-TA12-U-SS	1/2	3/4	53.8	22.9	22.2	20.6	10.4
A8-TA16-U-SS	1/2	1	60.2	22.9	22.2	27	10.4
A10-TA12-U-SS	5/8	3/4	54.6	24.4	25.4	23.8	12.7
A10-TA14-U-SS	5/8	7/8	56.1	24.4	25.4	23.8	12.7
A10-TA16-U-SS	5/8	1	61	24.4	25.4	27	12.7
A12-TA12-U-SS	3/4	3/4	54.6	24.4	28.6	27	14.7
A12-TA16-U-SS	3/4	1	62.5	24.4	28.6	27	15.7
A16-TA20-U-SS	1	11/4	80.5	31.2	38.1	34.9	22.4
A16-TA24-U-SS	1	11/2	89.2	31.2	38.1	41.3	22.4
A16-TA32-U-SS	1	2	112.5	31.2	38.1	54	22.4
A20-TA24-U-SS	11/4	11/2	104.1	41.1	47.6	47.6	27.7

型号	接口类型和尺寸		尺寸 mm				
	端口1 卡套 mm	端口2 卡套管 in.	L	C	G	F	E
A2M-TA3M-U-SS	2	3	33.5	12.9	12	12	1.7
A3M-TA4M-U-SS	3	4	35	12.9	12	12	2.4
A3M-TA6M-U-SS	3	6	36.1	12.9	12	12	2.4
A3M-TA10M-U-SS	3	10	38.4	12.9	12	14	2.4
A4M-TA6M-U-SS	4	6	37.1	13.7	12	12	2.4
A6M-TA3M-U-SS	6	3	36.9	15.3	14	14	1.9
A6M-TA8M-U-SS	6	8	39.9	15.3	14	14	4.8
A6M-TA10M-U-SS	6	10	40.7	15.3	14	14	4.8
A6M-TA12M-U-SS	6	12	46.3	15.3	14	14	4.8
A6M-TA18M-U-SS	6	18	49.6	15.3	14	22	4.8
A8M-TA6M-U-SS	8	6	40.3	16.2	16	15	4.1
A8M-TA10M-U-SS	8	10	42	16.2	16	15	6.4
A8M-TA12M-U-SS	8	12	47.6	16.2	16	15	6.4
A10M-TA6M-U-SS	10	6	42.4	17.2	19	18	4.1
A10M-TA8M-U-SS	10	8	43.4	17.2	19	18	5.6
A10M-TA12M-U-SS	10	12	49.8	17.2	19	18	7.9
A10M-TA15M-U-SS	10	15	51.3	17.2	19	18	7.9
A10M-TA18M-U-SS	10	18	51.3	17.2	19	22	7.9
A12M-TA6M-U-SS	12	6	44.9	22.8	22	22	4.1
A12M-TA8M-U-SS	12	8	45.9	22.8	22	22	5.6
A12M-TA10M-U-SS	12	10	46.7	22.8	22	22	7.1
A12M-TA16M-U-SS	12	16	53.8	22.8	22	22	9.5
A12M-TA18M-U-SS	12	18	53.8	22.8	22	22	9.5
A12M-TA20M-U-SS	12	20	56.1	22.8	22	22	9.5
A12M-TA22M-U-SS	12	22	56.1	22.8	22	24	9.5
A12M-TA25M-U-SS	12	25	62.4	22.8	22	27	9.5
A16M-TA12M-U-SS	16	12	53	24.4	25	24	8.8
A18M-TA12M-U-SS	18	12	54.6	24.4	30	27	8.8
A18M-TA16M-U-SS	18	16	56.1	24.4	30	27	12
A18M-TA20M-U-SS	18	20	57.6	24.4	30	27	15.1
A18M-TA22M-U-SS	18	22	57.6	24.4	30	27	15.1
A18M-TA25M-U-SS	18	25	62.4	24.4	30	27	15.1
A20M-TA16M-U-SS	20	16	57.9	26	32	30	12
A20M-TA18M-U-SS	20	18	57.9	26	32	30	13.9
A20M-TA22M-U-SS	20	22	59.4	26	32	30	15.9
A20M-TA25M-U-SS	20	25	64.2	26	32	30	15.8
A22M-TA18M-U-SS	22	18	57.9	26	32	30	13.9
A22M-TA20M-U-SS	22	20	59.4	26	32	30	15.5
A22M-TA25M-U-SS	22	25	64.2	26	32	30	18.3
A25M-TA18M-U-SS	25	18	63.1	31.3	38	35	13.9
A25M-TA20M-U-SS	25	20	64.6	31.3	38	35	15.5

孔口等径接头

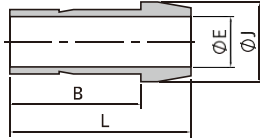

型号	接管 外径	尺寸 mm				
		in.	L	B	E	J
PO1-TA1-U-SS	1/16	13.7	10.7	0.8	3.3	
PO2-TA2-U-SS	1/8	22.4	15.7	2	6.1	
PO4-TA4-U-SS	1/4	24.6	18.8	4.3	9.4	
PO5-TA5-U-SS	5/16	25.9	20.1	5.6	10.9	
PO6-TA6-U-SS	3/8	26.2	20.3	6.9	12.7	
PO8-TA8-U-SS	1/2	35.8	25.9	9.4	15.7	
PO10-TA10-U-SS	5/8	41.7	28.1	11.9	20.5	
PO12-TA12-U-SS	3/4	41.9	27.7	14.7	22.1	
PO16-TA16-U-SS	1	48	34.5	20.3	28.4	
PO20-TA20-U-SS	1 1/4	69.1	50.6	25.9	37.4	
PO24-TA24-U-SS	1 1/2	88.4	63.6	31.5	47	

型号	接管 外径	尺寸 mm				
		mm	L	B	E	J
PO3M-TA3M-U-SS	3	22.2	15.7	1.9	6	
PO6M-TA6M-U-SS	6	24.6	18.7	4.1	9	
PO8M-TA8M-U-SS	8	25.9	20	5.6	11	
PO10M-TA10M-U-SS	10	26.1	20.2	7.1	13.1	
PO12M-TA12M-U-SS	12	35.8	26	8.8	15	
PO15M-TA15M-U-SS	15	37.8	27.6	11.2	19.6	
PO16M-TA16M-U-SS	16	37.8	27.6	12	20.6	
PO18M-TA18M-U-SS	18	37.8	27.7	13.9	21	
PO20M-TA20M-U-SS	20	39.4	29.2	15.5	24.6	
PO25M-TA25M-U-SS	25	49.3	34.5	19.9	31.2	
PO28M-TA28M-U-SS	28	63.5	48.3	22.5	34.4	
PO30M-TA30M-U-SS	30	67.6	52.2	24.3	37.4	
PO32M-TA32M-U-SS	32	69.7	52.4	26.5	39.4	
PO38M-TA38M-U-SS	38	81.9	61.4	31.6	45.8	

孔口变径接头

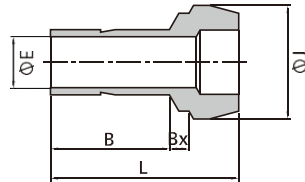

型号	接口尺寸		尺寸 mm					
	端口1 in.	端口2 in.	L	B	E	BX	J	
PO2-TA1-U-SS	1/8	1/16	17.3	8.6	0.8	2	6.1	
PO4-TA1-U-SS	1/4	1/16	18	8.6	0.8	3.6	9.4	
PO4-TA2-U-SS	1/4	1/8	22.6	13.5	2	3.3	9.4	
PO6-TA2-U-SS	3/8	1/8	23.1	13.5	2	3.8	12.7	
PO6-TA4-U-SS	3/8	1/4	24.9	15.7	4.3	3.3	12.7	
PO8-TA4-U-SS	1/2	1/4	29.2	15.7	4.3	3.8	15.7	
PO8-TA6-U-SS	1/2	3/8	30.5	17.5	6.9	3.3	15.7	
PO12-TA8-U-SS	3/4	1/2	37.8	23.1	9.4	3.8	22.1	
PO16-TA8-U-SS	1	1/2	42.9	24.4	9.4	4.8	28.5	
PO16-TA12-U-SS	1	3/4	43.7	25.9	14.7	4.1	28.5	

型号	接口尺寸		尺寸 mm					
	端口1 mm	端口2 mm	L	B	E	BX	J	
PO6M-TA3M-U-SS	6	3	22.6	13.5	1.9	3.2	9	
PO8M-TA6M-U-SS	8	6	24.7	15.7	4.1	3.1	11	
PO10M-TA6M-U-SS	10	6	25	15.7	4.1	3.4	13.1	
PO10M-TA8M-U-SS	10	8	26.3	17	5.6	3.1	13.1	
PO12M-TA6M-U-SS	12	6	29.6	15.7	4.1	3.6	15	
PO12M-TA8M-U-SS	12	8	29.8	16.8	5.6	3.4	15	
PO12M-TA10M-U-SS	12	10	30.4	17.5	7.1	3.1	15	
PO16M-TA12M-U-SS	16	12	36.2	23.1	8.8	3.4	19	
PO28M-TA25M-U-SS	28	25	56.5	33	19.8	8.2	34.3	
PO32M-TA25M-U-SS	32	25	60.3	33	19.8	9.9	39.5	
PO38M-TA25M-U-SS	38	25	65.8	33	19.8	12.3	47.1	

NPT外螺纹-卡套管直通

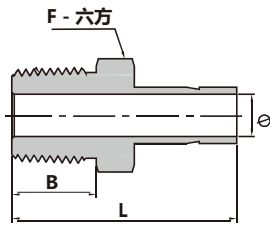

型号	接口类型和尺寸		尺寸 mm			
	端口1 MNPT in.	端口2 卡套管 in.	L	B	E	F
TA1-M2-U-SS	1/16	1/8	25.4	9.7	0.8	11.1
TA2-M2-U-SS	1/8	1/8	29.5	9.7	2	11.1
TA2-M4-U-SS	1/8	1/4	34.8	14.2	2	14.3
TA3-M2-U-SS	3/16	1/8	30.2	9.7	3	11.1
TA3-M4-U-SS	3/16	1/4	35.6	14.2	3	14.3
TA4-M2-U-SS	1/4	1/8	31.8	9.7	4.3	11.1
TA4-M4-U-SS	1/4	1/4	37.1	14.2	4.3	14.3
TA4-M6-U-SS	1/4	3/8	37.8	14.2	4.3	17.5
TA4-M8-U-SS	1/4	1/2	43.4	19.1	4.3	22.2
TA5-M2-U-SS	5/16	1/8	32.8	9.7	4.8	11.1
TA5-M4-U-SS	5/16	1/4	38.1	14.2	5.6	14.3
TA5-M6-U-SS	5/16	3/8	38.9	14.2	5.6	17.5
TA5-M8-U-SS	5/16	1/2	44.2	19.1	5.6	22.2
TA6-M2-U-SS	3/8	1/8	33.5	9.7	4.8	11.1
TA6-M4-U-SS	3/8	1/4	38.9	14.2	6.9	14.3
TA6-M6-U-SS	3/8	3/8	39.6	14.2	6.9	17.5
TA6-M8-U-SS	3/8	1/2	45.2	19.1	6.9	22.2
TA8-M4-U-SS	1/2	1/4	44.5	14.2	7.1	14.3
TA8-M6-U-SS	1/2	3/8	45.2	14.2	9.4	17.5
TA8-M8-U-SS	1/2	1/2	50.8	19.1	9.4	22.2
TA10-M8-U-SS	5/8	1/2	52.3	19.1	11.9	22.2
TA12-M8-U-SS	3/4	1/2	52.3	19.1	11.9	22.2
TA12-M12-U-SS	3/4	3/4	52.3	19.1	14.7	27
TA12-M16-U-SS	3/4	1	61.2	23.9	14.7	34.9
TA16-M12-U-SS	1	3/4	58.7	19.1	15.7	27
TA16-M16-U-SS	1	1	66	23.9	20.3	34.9
TA20-M20-U-SS	1 1/4	1 1/4	80.3	23.9	25.9	44.5
TA24-M24-U-SS	1 1/2	1 1/2	94.5	26.2	31.8	54

NPT内螺纹-卡套管直通

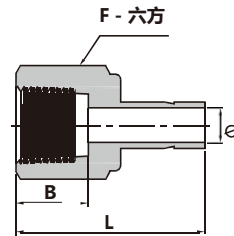

型号	接口类型和尺寸		尺寸mm			
	端口1 卡套管 in.	端口 2FNPT in.	L	B	E	F
TA1-F2-U-SS	1/16	1/8	27.2	10.4	0.8	14.3
TA2-F2-U-SS	1/8	1/8	31.5	10.4	2	14.3
TA2-F4-U-SS	1/8	1/4	35.3	15	2	19.1
TA3-F2-U-SS	3/16	1/8	31.8	10.4	2.9	14.3
TA3-F4-U-SS	3/16	1/4	35.8	15	3	19.1
TA4-F2-U-SS	1/4	1/8	33	10.4	4.3	14.3
TA4-F4-U-SS	1/4	1/4	37.1	15	4.3	19.1
TA4-F6-U-SS	1/4	3/8	39.4	15	4.3	22.2
TA4-F8-U-SS	1/4	1/2	45.5	19.8	4.3	27
TA5-F2-U-SS	5/16	1/8	34	10.4	5.6	14.3
TA5-F4-U-SS	5/16	1/4	37.6	15	5.6	19.1
TA5-F6-U-SS	5/16	3/8	40.4	15	5.6	22.2
TA6-F2-U-SS	3/8	1/8	34.3	10.4	6.9	14.3
TA6-F4-U-SS	3/8	1/4	38.1	15	6.9	19.1
TA6-F6-U-SS	3/8	3/8	40.4	15	6.9	22.2
TA6-F8-U-SS	3/8	1/2	46.7	19.8	6.9	27
TA8-F4-U-SS	1/2	1/4	43.4	15	9.4	19.1
TA8-F6-U-SS	1/2	3/8	45.5	15	9.4	22.2
TA8-F8-U-SS	1/2	1/2	51.8	19.8	9.4	27
TA10-F6-U-SS	5/8	3/8	47.2	15	11.9	22.2
TA10-F8-U-SS	5/8	1/2	53.1	19.8	11.9	27
TA12-F8-U-SS	3/4	1/2	52.8	19.8	14.7	27
TA12-F12-U-SS	3/4	3/4	54.9	20.6	14.7	33.3
TA12-F16-U-SS	3/4	1	58.4	25.4	14.7	41.3
TA14-F12-U-SS	7/8	3/4	56.4	20.6	17.5	33.3
TA16-F12-U-SS	1	3/4	60.7	20.6	20.3	33.3
TA16-F16-U-SS	1	1	64.3	25.4	20.3	41.3
TA20-F20-U-SS	1 1/4	1 1/4	77.7	25.4	25.9	54
TA24-F24-U-SS	1 1/2	1 1/2	88.9	27.7	31.8	60.3

卡套-软管接口直通

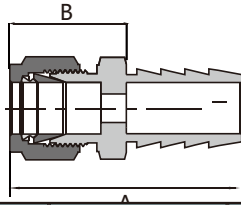

型号	接口类型和尺寸		尺寸 mm	
	端口1 卡套 in.	端口2 软管插头 in.	A	B
A2-IN2-U-SS	1/8	1/8	36.1	25.9
A2-IN4-U-SS	1/8	1/4	46	25.9
A4-IN4-U-SS	1/4	1/4	48.8	28.7
A4-IN6-U-SS	1/4	3/8	50.6	28.5
A6-IN6-U-SS	3/8	3/8	52.3	30.2
A8-IN8-U-SS	1/2	1/2	56.9	33

卡套管-软管接口直通

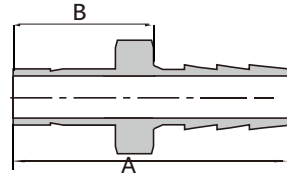

型号	接口类型和尺寸		尺寸 mm	
	端口1 卡套管 in.	端口2 软管插头 in.	A	B
TA2-IN2-U-SS	1/8	1/8	34.5	24.4
TA4-IN2-U-SS	1/4	1/8	36.8	26.7
TA4-IN4-U-SS	1/4	1/4	47	26.9
TA4-IN5-U-SS	1/4	5/16	49	26.9
TA4-IN6-U-SS	1/4	3/8	49	26.9
TA6-IN4-U-SS	3/8	1/4	48.5	28.4
TA6-IN6-U-SS	3/8	3/8	50.5	28.4
TA6-IN8-U-SS	3/8	1/2	52.3	28.4
TA8-IN6-U-SS	1/2	3/8	57.2	35.1
TA8-IN8-U-SS	1/2	1/2	58.9	35.1
TA12-IN12-U-SS	3/4	3/4	63.3	36.6
TA16-IN16-U-SS	1	1	77.5	47.2

NPT外螺纹-软管接口直通

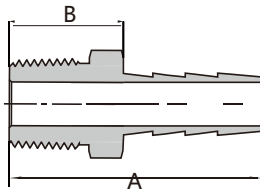

型号	接口类型和尺寸		尺寸 mm	
	端口1 MNPT in.	端口2 软管插头 in.	A	B
M2-IN2-U-SS	1/8	1/8	27.4	17.3
M2-IN3-U-SS	1/8	3/16	32.2	17.3
M2-IN4-U-SS	1/8	1/4	37.3	17.3
M2-IN5-U-SS	1/8	5/16	39.4	17.3
M4-IN2-U-SS	1/4	1/8	32	21.8
M4-IN3-U-SS	1/4	3/16	36.8	21.8
M4-IN4-U-SS	1/4	1/4	41.9	21.8
M4-IN5-U-SS	1/4	5/16	43.9	21.8
M4-IN6-U-SS	1/4	3/8	43.9	21.8
M4-IN8-U-SS	1/4	1/2	45.7	21.8
M6-IN4-U-SS	3/8	1/4	42.2	22.1
M6-IN5-U-SS	3/8	5/16	44.2	22.1
M6-IN6-U-SS	3/8	3/8	44.2	22.1
M6-IN8-U-SS	3/8	1/2	46	22.1
M6-IN10-U-SS	3/8	5/8	47.8	22.9
M8-IN4-U-SS	1/2	1/4	47	26.9
M8-IN5-U-SS	1/2	5/16	49.8	27.7
M8-IN6-U-SS	1/2	3/8	49.8	27.7
M8-IN8-U-SS	1/2	1/2	51.6	27.7
M8-IN10-U-SS	1/2	5/8	52.6	27.7
M8-IN12-U-SS	1/2	3/4	54.4	27.7
M12-IN10-U-SS	3/4	5/8	52.6	27.7
M12-IN12-U-SS	3/4	3/4	54.4	27.7
M12-IN16-U-SS	3/4	1	60.5	30.2
M16-IN12-U-SS	1	3/4	61.7	35.1
M16-IN16-U-SS	1	1	65.3	35.1

NPT内螺纹-软管接口直通

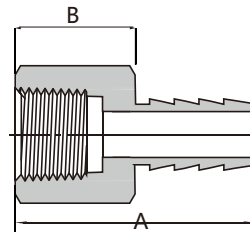

型号	接口类型和尺寸		尺寸 mm	
	端口1 FNPT in.	端口2 软管插头 in.	A	B
F2-IN2-U-SS	1/8	1/8	28.2	18
F2-IN3-U-SS	1/8	3/16	32.8	17.8
F2-IN4-U-SS	1/8	1/4	37.3	17.3
F2-IN2-U-SS	1/4	1/8	32	21.8
F4-IN3-U-SS	1/4	3/16	36.6	21.6
F4-IN4-U-SS	1/4	1/4	41.7	21.6
F4-IN5-U-SS	1/4	5/16	43.9	21.8
F4-IN6-U-SS	1/4	3/8	42.9	20.8
F6-IN4-U-SS	3/8	1/4	43.4	23.4
F6-IN5-U-SS	3/8	5/16	46.2	24.1
F6-IN6-U-SS	3/8	3/8	45.2	23.1
F8-IN6-U-SS	1/2	3/8	51.6	29.5
F8-IN8-U-SS	1/2	1/2	54.1	30.2

软管支撑件

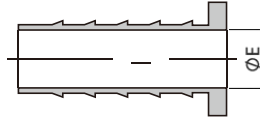

型号	接口类型和尺寸		尺寸 mm
	端口 1 软管插口 in.	端口 2 卡套管口 in.	E
3-2-IN-SS	3/16	1/8	2.3
4-2-IN-SS	1/4	1/8	2.3
4-3-IN-SS	1/4	3/16	3.5
5-2-IN-SS	5/16	1/8	2.3
5-3-IN-SS	5/16	3/16	3
5-4-IN-SS	5/16	1/4	4.8
6-3-IN-SS	3/8	3/16	3
6-4-IN-SS	3/8	1/4	4.8
8-4-IN-SS	1/2	1/4	4.8
8-6-IN-SS	1/2	3/8	7.9
10-6-IN-SS	5/8	3/8	7.9
10-8-IN-SS	5/8	1/2	11.1
12-8-IN-SS	3/4	1/2	11.1
12-10-IN-SS	3/4	5/8	14.2
16-12-IN-SS	1	3/4	17.5

NPT外螺纹-NPT外螺纹直通

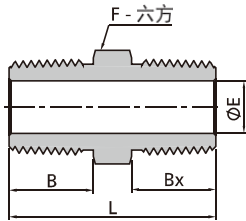

型号	接口类型和尺寸		尺寸 mm				
	端口1 MNPT in.	端口2 MNPT in.	L	F	B	Bx	E
M1-U-SS	1/16	1/16	25.6	7.9	9.7	9.7	3
M2-M1-U-SS	1/8	1/16	25.6	11.1	9.7	9.7	3
M2-U-SS	1/8	1/8	25.6	11.1	9.7	9.7	4.8
M4-M1-U-SS	1/4	1/16	31	14.3	14.2	9.7	3
M4-M2-U-SS	1/4	1/8	31	14.3	14.2	9.7	4.8
M4-U-SS	1/4	1/4	35.6	14.3	14.2	14.2	7.1
M6-M1-U-SS	3/8	1/16	31.8	17.5	14.2	9.7	3
M6-M2-U-SS	3/8	1/8	31.8	17.5	14.2	9.7	4.8
M6-M4-U-SS	3/8	1/4	36.3	17.5	14.2	14.2	7.1
M6-U-SS	3/8	3/8	36.3	17.5	14.2	14.2	9.7
M8-M2-U-SS	1/2	1/8	37.3	22.2	19.1	9.7	4.8
M8-M4-U-SS	1/2	1/4	41.9	22.2	19.1	14.2	7.1
M8-M6-U-SS	1/2	3/8	41.9	22.2	19.1	14.2	9.7
M8-U-SS	1/2	1/2	46.7	22.2	19.1	19.1	11.9
M12-M2-U-SS	3/4	1/8	40.4	27	19.1	9.7	4.8
M12-M4-U-SS	3/4	1/4	41.9	27	19.1	14.2	7.1
M12-M6-U-SS	3/4	3/8	45.2	27	19.1	14.2	9.7
M12-M8-U-SS	3/4	1/2	46.7	27	19.1	19.1	11.9
M12-U-SS	3/4	3/4	46.7	27	19.1	19.1	15.7
M16-M2-U-SS	1	1/8	45.2	34.9	23.9	9.7	4.8
M16-M4-U-SS	1	1/4	49.3	34.9	23.9	14.2	7.1
M16-M6-U-SS	1	3/8	50	34.9	23.9	14.2	9.7
M16-M8-U-SS	1	1/2	54.1	34.9	23.9	19.1	11.9
M16-M12-U-SS	1	3/4	54.1	34.9	23.9	19.1	15.7
M16-U-SS	1	1	58.9	34.9	23.9	23.9	22.4
M20-M16-U-SS	11/4	1	62.2	44.5	23.9	23.9	22.4
M20-U-SS	11/4	11/4	62.9	44.5	23.9	23.9	28.6
M24-U-SS	11/2	11/2	66.3	50.8	26.2	26.2	34
M32-U-SS	2	2	77.7	69.9	26.2	26.2	45

NPT外螺纹-ISO平行外螺纹直通

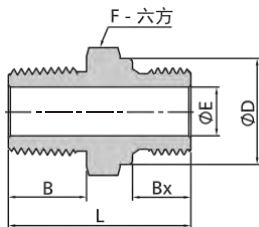

型号	接口类型和尺寸		尺寸 mm					
	端口1 MNPT in.	端口2 ISO直螺纹 in.	L	F	B	Bx	E	D
M2-MGA2-U-SS	1/8	1/8	27.7	14.3	9.7	7.1	4.1	13.7
M4-MGA4-U-SS	1/4	1/4	36.8	19.1	14.2	11.2	5.8	18
M6-MGA6-U-SS	3/8	3/8	37.6	22.2	14.2	11.2	7.9	21.6
M8-MGA8-U-SS	1/2	1/2	44.4	27	19.1	14.2	11.9	25.9
M12-MGA12-U-SS	3/4	3/4	49	33.3	19.1	15.7	15.7	32
M16-MGA16-U-SS	1	1	56.6	41.3	23.9	18.3	19.8	38.9

NPT外螺纹-SAE/MS平行外螺纹直通

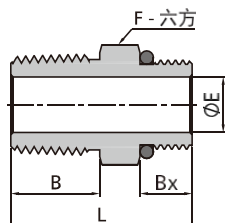

型号	接口类型和尺寸		尺寸 mm				
	端口1 MNPT in.	端口2 ISO直螺纹 in.	L	F	B	Bx	E
M4-MUNF7/16-20-U-SS	1/4	7/16-20	30.5	14.3	14.2	9.1	5.1
M6-MUNF9/16-18-U-SS	3/8	9/16-18	32	17.5	14.2	9.1	7.1
M8-MUNF3/4-16-U-SS	1/2	3/4-16	38.9	22.2	19.1	11.2	10.7
M12-MUNF11/16-12-U-SS	3/4	11/16-12	44.4	31.8	19.1	15	15.7
M16-MUNF15/16-12-U-SS	1	15/16-12	50.8	38.1	23.9	15	22.4

NPT外螺纹-公制外螺纹直通

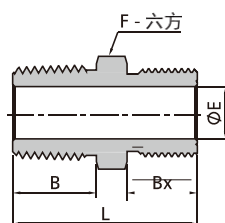

型号	接口类型和尺寸		尺寸 mm				
	端口1 MNPT in.	端口2 公制外螺纹 in.	L	F	B	Bx	E
M2-MM20*1.5-U-SS	1/8	M20x1.5	32.7	22.2	9.7	16	5
M4-MM8*1-U-SS	1/4	M8x1	29	14.3	14.2	9	3.2
M4-MM14*1.5-U-SS	1/4	M14x1.5	34.2	15.9	14.2	13	7
M4-MM16*1.5-U-SS	1/4	M16x1.5	35.2	17.5	14.2	14	7.1
M4-MM20*1.5-U-SS	1/4	M20x1.5	37.2	22.2	14.2	16	7.1
M6-MM14*1.5-U-SS	3/8	M14x1.5	34.2	17.5	14.2	13	7
M6-MM20*1.5-U-SS	3/8	M20x1.5	37.2	22.2	14.2	16	9.5
M6-MM24*1.5-U-SS	3/8	M24x1.5	38.2	25.4	14.2	17	9.5
M8-MM14*1.5-U-SS	1/2	M14x1.5	39.1	22.2	19.1	13	7.2
M8-MM20*1.5-U-SS	1/2	M20x1.5	42	22.2	19.1	16	10
M8-MM24*1.5-U-SS	1/2	M24x1.5	43.5	25.4	19.1	17	11.9
M12-MM20*1.5-U-SS	3/4	M20x1.5	42.1	27	19.1	16	10.8
M12-MM27*2-U-SS	3/4	M27x2	46.7	31.8	19.1	18	15.8
M16-MM30*2-U-SS	1	M30x2	56.3	34.9	23.9	20	19.4

ISO平行外螺纹-公制外螺纹直通

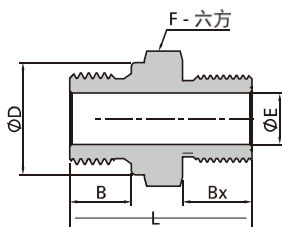

型号	接口类型和尺寸		尺寸 mm					
	端口1 ISO平行外螺纹 in.	端口2 公制外螺纹 in.	L	F	B	Bx	E	D
MGA2-MM20*1.5-U-SS	1/8	M20x1.5	32.6	22.2	7.1	16	4	13.7
MGA4-MM18*1.5-U-SS	1/4	M18x1.5	34.2	20.6	11.2	15	5.9	18
MGA4-MM20*1.5-U-SS	1/4	M20x1.5	37.2	22.2	11.2	16	5.9	18
MGA6-MM20*1.5-U-SS	3/8	M20x1.5	37.2	22.2	11.2	16	7.9	21.6
MGA8-MM20*1.5-U-SS	1/2	M20x1.5	40.2	27	14	16	11.9	25.9

公制外螺纹-公制外螺纹直通

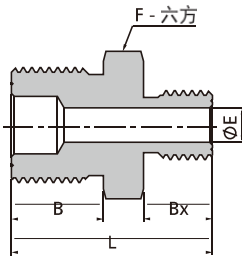

型号	接口类型和尺寸		尺寸 mm				
	端口1 公制外螺纹 in.	端口2 公制外螺纹 in.	L	F	B	Bx	E
MM20*1.5-MM10*1-U-SS	M20x1.5	M10x1	34	22	16	11	4
MM20*1.5-MM12*1.5-U-SS	M20x1.5	M12x1.5	35	22	16	12	6
MM20*1.5-MM14*1.5-U-SS	M20x1.5	M14x1.5	36	22	16	13	7.2
MM20*1.5-MM16*1.5-U-SS	M20x1.5	M16x1.5	37	22	16	14	9
MM20*1.5-MM20*1.5-U-SS	M20x1.5	M20x1.5	39	22	16	16	10.8
MM27*2-MM27*2-U-SS	M27x2	M27x2	44.5	30	18	18	16.1

NPT外螺纹加长直通

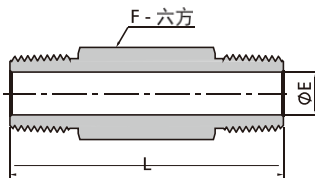

型号	接口类型	尺寸 mm		
	端口 MNPT in.	L	F	E
M2L38MM-U-SS	1/8	38	11.1	4.8
M2L51MM-U-SS	1/8	51	11.1	4.8
M2L64MM-U-SS	1/8	64	11.1	4.8
M2L76MM-U-SS	1/8	76	11.1	4.8
M4L38MM-U-SS	1/4	38	14.3	7.1
M4L51MM-U-SS	1/4	51	14.3	7.1
M4L64MM-U-SS	1/4	64	14.3	7.1
M4L76MM-U-SS	1/4	76	14.3	7.1
M4L102MM-U-SS	1/4	102	14.3	7.1
M6L38MM-U-SS	3/8	38	17.5	9.7
M6L51MM-U-SS	3/8	51	17.5	9.7
M6L64MM-U-SS	3/8	64	17.5	9.7
M6L76MM-U-SS	3/8	76	17.5	9.7
M6L102MM-U-SS	3/8	102	17.5	9.7
M8L51MM-U-SS	1/2	51	22.2	11.9
M8L76MM-U-SS	1/2	76	22.2	11.9
M8L102MM-U-SS	1/2	102	22.2	11.9
M8L152MM-U-SS	1/2	152	22.2	11.9
M12L51MM-U-SS	3/4	51	27	15.7
M12L76MM-U-SS	3/4	76	27	15.7
M12L102MM-U-SS	3/4	102	27	15.7
M16L76MM-U-SS	1	76	34.9	22.4
M16L102MM-U-SS	1	102	34.9	22.4

NPT外螺纹-NPT内螺纹直通

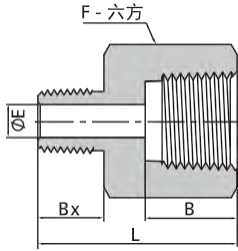

型号	接口类型和尺寸		尺寸 mm				
	端口1 MNPT in.	端口2 FNPT in.	L	F	B	Bx	E
M1-F2-U-SS	1/16	1/8	27.7	14.3	10.4	9.7	3
M2-F2-U-SS	1/8	1/8	27.9	14.3	10.4	9.7	4.8
M1-F4-U-SS	1/16	1/4	30.5	19.1	15	9.7	3
M2-F4-U-SS	1/8	1/4	32	19.1	15	9.7	4.8
M4-F4-U-SS	1/4	1/4	35.6	19.1	15	14.2	7.1
M1-F6-U-SS	1/16	3/8	31.8	22.2	15	9.7	3
M2-F6-U-SS	1/8	3/8	33.8	22.2	15	9.7	4.8
M4-F6-U-SS	1/4	3/8	38.1	22.2	15	14.2	7.1
M6-F6-U-SS	3/8	3/8	38.4	22.2	15	14.2	9.6
M2-F8-U-SS	1/8	1/2	40.1	27	19.8	9.7	4.8
M4-F8-U-SS	1/4	1/2	44.7	27	19.8	14.2	7.1
M6-F8-U-SS	3/8	1/2	44.4	27	19.8	14.2	9.6
M8-F8-U-SS	1/2	1/2	49.3	27	19.8	19.1	11.9
M2-F12-U-SS	1/8	3/4	39.6	33.3	20.6	9.7	4.8
M4-F12-U-SS	1/4	3/4	47	33.3	20.6	14.2	7.1
M6-F12-U-SS	3/8	3/4	46.2	33.3	20.6	14.2	9.6
M8-F12-U-SS	1/2	3/4	51.3	33.3	20.6	19.1	11.9
M12-F12-U-SS	3/4	3/4	51.3	33.3	20.6	19.1	15.7
M2-F16-U-SS	1/8	1	46	41.3	25.4	9.7	4.8
M4-F16-U-SS	1/4	1	49.8	41.3	25.4	14.2	7.1
M6-F16-U-SS	3/8	1	50.8	41.3	25.4	14.2	9.6
M8-F16-U-SS	1/2	1	54.9	41.3	25.4	19.1	11.9
M12-F16-U-SS	3/4	1	55.1	41.3	25.4	19.1	15.7
M16-F16-U-SS	1	1	57.9	41.3	25.4	23.9	22.4
M16-F20-U-SS	1	1 1/4	62.7	54	25.4	23.9	22.4

ISO平行外螺纹-NPT内螺纹直通 (根部复合垫片密封)

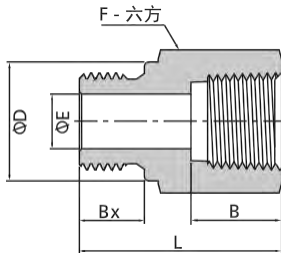

型号	接口类型和尺寸		尺寸 mm					
	端口1 ISO平行外螺纹 in.	端口2 FNPT in.	L	F	B	Bx	E	D
MGA2-F2-U-SS	1/8	1/8	25.1	14.3	9.9	7.1	13.7	4.1
MGA4-F4-U-SS	1/4	1/4	33.5	19.1	10.4	11.2	18	5.8
MGA6-F6-U-SS	3/8	3/8	35.8	22.2	15	11.2	21.6	7.9
MGA8-F8-U-SS	1/2	1/2	44.2	27	15	14.2	25.9	11.9
MGA12-F12-U-SS	3/4	3/4	48	33.3	20.6	15.7	32	15.7
MGA16-F16-U-SS	1	1	53.3	41.3	25.4	18.3	38.9	19.8

SAE/MS外螺纹-NPT内螺纹直通

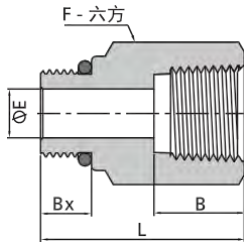

型号	接口类型和尺寸		尺寸 mm				
	端口1 SAE/MS外螺纹 in.	端口2 FNPT in.	L	F	B	Bx	E
MUNF7/16-20-F4-U-SS	7/16-20	1/4	33.5	19.1	15	9.1	5.1
MUNF9/16-18-F6-U-SS	9/16-18	3/8	35.3	23.8	15	9.9	7.1
MUNF3/4-16-F8-U-SS	3/4-16	1/2	44.7	27	19.8	11.2	10.7
MUNF1 1/16-12-F12-U-SS	11/16-12	3/4	50.5	34.9	20.6	15	16.8
MUNF1 5/16-12-F16-U-SS	15/16-12	1	53.8	41.3	25.4	15	21.5

NPT外螺纹-ISO平行内螺纹直通

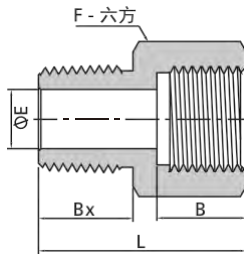

型号	接口类型和尺寸		尺寸 mm				
	端口1 MNPT in.	端口2 ISO平行内螺纹 in.	L	F	B	Bx	E
M2-FG2-U-SS	1/8	1/8	21.8	14.3	6.5	9.7	4.5
M4-FG4-U-SS	1/4	1/4	30.2	19.1	12.9	14.2	5.5
M6-FG6-U-SS	3/8	3/8	32.2	23.8	14.2	14.2	6.5
M6-FG4-U-SS	3/8	1/4	30.2	19.1	14.2	12.9	5.6
M8-FG8-U-SS	1/2	1/2	42.7	27	18.8	19.1	7
M8-FG6-U-SS	1/2	3/8	35.8	22.2	19.1	14.2	6.6
M12-FG8-U-SS	3/4	1/2	41.4	27	19.1	18.8	7.1

NPT补芯

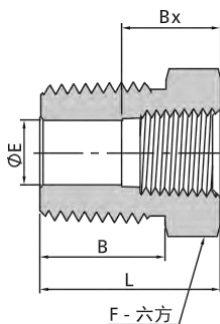

型号	接口类型和尺寸		尺寸 mm				
	端口1 MNPT in.	端口2 FNPT in.	L	F	B	Bx	E
M2-F1-U-SS	1/8	1/16	26.2	11.1	9.7	9.9	4.8
M4-F1-U-SS	1/4	1/16	21.8	14.3	14.2	9.9	4.8
M4-F2-U-SS	1/4	1/8	26.9	14.3	14.2	10.4	7.1
M6-F1-U-SS	3/8	1/16	21.8	17.5	14.2	9.9	4.8
M6-F2-U-SS	3/8	1/8	21.8	17.5	14.2	10.4	8.6
M6-F4-U-SS	3/8	1/4	30.2	19.1	14.2	15	9.6
M8-F1-U-SS	1/2	1/8	27.4	22.2	19.1	10.4	8.6
M8-F4-U-SS	1/2	1/4	27.4	22.2	19.1	15	11.4
M8-F6-U-SS	1/2	3/8	35.8	22.2	19.1	15	11.9
M12-F4-U-SS	3/4	1/4	27.4	27	19.1	15	11.4
M12-F6-U-SS	3/4	3/8	27.4	27	19.1	15	15
M12-F8-U-SS	3/4	1/2	41.4	27	19.1	19.8	15.7
M16-F4-U-SS	1	1/4	34.8	34.9	23.9	15	11.4
M16-F6-U-SS	1	3/8	34.8	34.9	23.9	15	15
M16-F8-U-SS	1	1/2	34.8	34.9	23.9	19.8	18.5
M16-F12-U-SS	1	3/4	47	34.9	23.9	20.6	22.4
M20-F12-U-SS	11/4	3/4	37.3	44.5	23.9	20.6	22.4
M20-F16-U-SS	11/4	1	37.3	44.5	23.9	25.4	22.4
M24-F16-U-SS	11/2	1	40.1	50.8	26.2	25.4	22.4
M24-F20-U-SS	11/2	11/4	56	54	26.2	25.4	34

NPT外螺纹-公制内螺纹活接直通

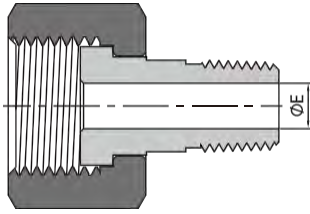

型号	接口类型和尺寸		尺寸 mm
	端口1 MNPT in.	端口2 公制外螺纹 in.	E
M2-FM20*1.5-UA-SS	1/8	M20x1.5	4.8
M4-FM20*1.5-UA-SS	1/4	M20x1.5	7.1

压力表定向接头



型号	接口类型和尺寸	
	端口1 in.	端口2 in.
M8-F8-PGI-UA-SS	1/2MNPT	1/2FNPT
M8-FG8-PGI-UA-SS	1/2MNPT	G1/2F
MG8-FG8-PGI-UA-SS	G1/2M	G1/2F

NPT内螺纹直通

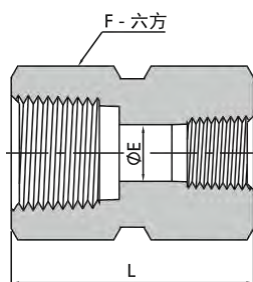

型号	接口类型和尺寸		尺寸 mm		
	端口1 MNPT in.	端口2 MNPT in.	L	F	E
F1-U-SS	1/16	1/16	19.8	11.1	4.8
F2-U-SS	1/8	1/8	20.6	14.3	8.6
F4-F2-U-SS	1/4	1/8	31	19.1	8.6
F4-U-SS	1/4	1/4	30.2	19.1	11.4
F6-F4-U-SS	3/8	1/4	35.1	22.2	11.4
F6-U-SS	3/8	3/8	33.3	22.2	15
F8-F2-U-SS	1/2	1/8	39.6	27	8.6
F8-F4-U-SS	1/2	1/4	44.4	27	11.4
F8-F6-U-SS	1/2	3/8	45.2	27	15
F8-U-SS	1/2	1/2	39.6	27	18.5
F12-F4-U-SS	3/4	1/4	46	33.3	11.4
F12-F8-U-SS	3/4	1/2	52.3	33.3	18.5
F12-U-SS	3/4	3/4	41.1	33.3	23.9
F16-F8-U-SS	1	1/2	55.6	41.3	18.5
F16-F12-U-SS	1	3/4	57.2	41.3	23.9
F16-U-SS	1	1	50.8	41.3	29.7

ISO锥形内螺纹 (55°) 直通

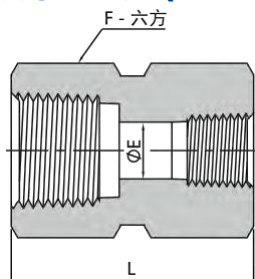

型号	接口类型和尺寸		尺寸mm		
	端口1 RC内螺纹 in.	端口2 RC 内螺纹 in.	L	F	E
FRC1-U-SS	1/16	1/16	19.8	11.1	4.8
FRC2-U-SS	1/8	1/8	20.6	14.3	8.6
FRC4-FRC2-U-SS	1/4	1/8	31	19.1	8.6
FRC4-U-SS	1/4	1/4	30.2	19.1	11.4
FRC6-FRC4-U-SS	3/8	1/4	35.1	22.2	11.4
FRC6-U-SS	3/8	3/8	33.3	22.2	15
FRC8-FRC2-U-SS	1/2	1/8	39.6	27	8.6
FRC8-FRC4-U-SS	1/2	1/4	44.4	27	11.4
FRC8-FRC6-U-SS	1/2	3/8	45.2	27	15
FRC8-U-SS	1/2	1/2	39.6	27	18.5
FRC12-FRC4-U-SS	3/4	1/4	46	33.3	11.4
FRC12-FRC8-U-SS	3/4	1/2	52.3	33.3	18.5
FRC12-U-SS	3/4	3/4	41.1	33.3	23.9
FRC16-FRC8-U-SS	1	1/2	55.6	41.3	18.5
FRC16-FRC12-U-SS	1	3/4	57.2	41.3	23.9
FRC16-U-SS	1	1	50.8	41.3	29.7

NPT内螺纹活接直通

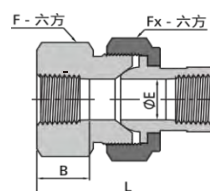

型号	接口类型和尺寸	尺寸 mm				
	端口 FNPT in.	L	F	FX	B	E
F2-UB-SS	1/8	46	23.8	28.6	10.4	6.8
F4-UB-SS	1/4	59.4	30.2	34.9	15	9.1
F6-UB-SS	3/8	63.5	33.3	38.1	15	13.2
F8-UB-SS	1/2	68.3	41.3	44.5	19.8	15.7
F12-UB-SS	3/4	79.2	47.6	54	20.6	22.4
F16-UB-SS	1	90.4	60.3	63.5	25.4	26.2

卡套管承插焊直通 (Tube SW)

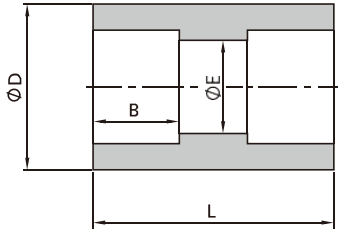

型号	接口类型和尺寸	尺寸 mm			
	插焊 in.	L	D	B	E
TSW4-U-SS	1/4	19.1	12.2	7.1	4.8
TSW6-U-SS	3/8	22.4	15.2	7.9	7.1
TSW8-U-SS	1/2	26.9	18.5	9.7	10.4
TSW10-U-SS	5/8	30.2	23.4	10.4	12.7
TSW12-U-SS	3/4	33.3	26.4	11.2	16
TSW14-U-SS	7/8	35.5	31.5	12.7	18.8
TSW16-U-SS	1	36.6	34.5	15.7	22.4

型号	接口类型和尺寸	尺寸 mm			
	插焊 mm	L	D	B	E
TSW8M-U-SS	8	22.4	14.3	7.9	6.4
TSW10M-U-SS	10	23.6	16.5	7.9	7.4
TSW12M-U-SS	12	26.9	20.2	9.7	9.5
TSW14M-U-SS	14	28	23.8	10	10.4
TSW16M-U-SS	16	30.2	23.8	10.4	12.7
TSW20M-U-SS	20	28	27	11.2	17

公称管承插焊直通 (Pipe SW)

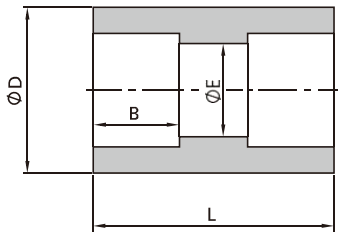

型号	接口类型和尺寸	尺寸mm			
	端口 Pipe 管插焊 in.	L	D	B	E
PSW2-U-SS	1/8	25.7	17.1	9.9	7
PSW4-U-SS	1/4	26.9	22.4	9.9	9.7
PSW6-U-SS	3/8	28.4	26.2	9.9	12.4
PSW8-U-SS	1/2	29.5	31.8	9.9	15.7
PSW12-U-SS	3/4	44.5	37.3	13	20.8
PSW16-U-SS	1	44.5	47.2	13	26.7

卡套管承插焊变径直通 (Tube SW)

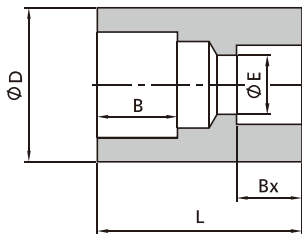

型号	接口类型和尺寸		尺寸 mm				
	端口1 Tube管插焊	端口2 Tube管插焊	L	D	B	E	Bx
TSW6-TSW4-U-SS	3/8in.	1/4in.	22.4	15.2	7.9	4.8	7.1
TSW8-TSW4-U-SS	1/2in.	1/4in.	24.3	18.5	9.7	4.8	7.1
TSW8-TSW6-U-SS	1/2in.	3/8in.	26.1	18.5	9.7	7.1	7.9
TSW12-TSW6-U-SS	3/4in.	3/8in.	29.8	26.4	11.2	7.1	7.9
TSW12-TSW8-U-SS	3/4in.	1/2in.	31.6	26.4	11.2	10.4	9.7
TSW16-TSW12-U-SS	1in.	3/4in.	32.1	34.5	15.7	16	11.2
TSW6-TSW4-U-SS	3/8in.	1/4in.	22.4	15.2	7.9	4.8	7.1
TSW14M-TSW10M-U-SS	14mm	10mm	26	23.8	10.4	7.4	7.9
TSW25M-TSW14M-U-SS	25mm	14mm	30	34.5	15.7	10.4	10
TSW25M-TSW22M-U-SS	25mm	22mm	35.8	34.5	15.7	19	13.5
TSW20M-TSW12-U-SS	20mm	3/4in.	28	27	11.2	15.7	11.2

卡套管对焊变径直通 (Tube BW)

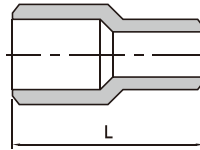

型号	接口类型和尺寸				尺寸 mm
	端口1 Tube管对焊		端口2 Tube管对焊		L
	外径 in.	壁厚 in.	外径 in.	壁厚 in.	
TBW6*095-TBW4*065-U-SS	3/8	0.095	1/4	0.065	38.1
TBW8*095-TBW4*065-U-SS	1/2	0.095	1/4	0.065	38.1
TBW8*095-TBW6*095-U-SS	1/2	0.095	3/8	0.095	38.1
TBW12*120-TBW8*095-U-SS	3/4	0.120	1/2	0.095	38.1
TBW16*134-TBW12*120-U-SS	1	0.134	3/4	0.120	38.1

型号	接口类型和尺寸				尺寸 mm
	端口1 Tube管对焊		端口2 Tube管对焊		L
	外径 mm	壁厚 mm	外径 mm	壁厚 mm	
TBW20M*3-TBW14M*2.5-U-SS	20	3.0	14	2.5	38.1
TBW22M*3-TBW14M*2.5-U-SS	22	3.0	14	2.5	38.1
TBW22M*3-TBW18M*2.8-U-SS	22	3.0	18	2.8	38.1
TBW25M*3.5-TBW22M*3-U-SS	25	3.5	22	3.0	38.1
TBW38M*5-TBW25M*3.5-U-SS	38	5.0	25	3.5	38.1

NPT外螺纹-卡套管承插焊 (Tube SW)

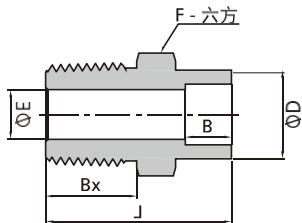

型号	接口类型和尺寸		尺寸 mm					
	端口1 MNPT in.	端口2 Tube管插焊 in.	L	D	B	Bx	F	E
M4-TSW4-U-SS	1/4	1/4	29.2	12.2	7.1	14.2	14.3	4.8
M4-TSW6-U-SS	1/4	3/8	31.8	15.2	7.9	14.2	15.9	7.1
M6-TSW6-U-SS	3/8	3/8	31.8	15.2	7.9	14.2	17.5	7.1
M8-TSW6-U-SS	1/2	3/8	37.3	15.2	7.9	19.1	22.2	7.1
M4-TSW8-U-SS	1/4	1/2	33.3	18.5	9.7	14.2	19.1	7.1
M6-TSW8-U-SS	3/8	1/2	33.3	18.5	9.7	14.2	19.1	9.6
M8-TSW8-U-SS	1/2	1/2	38.9	18.5	9.7	19.1	22.2	10.4
M12-TSW12-U-SS	3/4	3/4	45.1	26.4	11.2	19.1	27	15.7
M16-TSW16-U-SS	1	1	53.6	34.5	15.7	23.9	34.9	22.4

型号	接口类型和尺寸		尺寸 mm					
	端口1 MNPT in.	端口2 Tube管插焊 mm	L	D	B	Bx	F	E
M4-TSW6M-U-SS	1/4	6	29.2	12	7.1	14.2	14	4.8
M8-TSW12M-U-SS	1/2	12	38.9	20.2	9.7	19.1	22	9.5
M4-TSW14M-U-SS	1/4	14	33.3	23.8	10	14.2	24	7.1
M6-TSW14M-U-SS	3/8	14	35	23.8	10	14.2	24	9.6
M8-TSW14M-U-SS	1/2	14	40	23.8	10	19.1	24	10.4
M4-TSW16M-U-SS	1/4	16	35	23.8	10.4	14.2	24	7.1
M8-TSW16M-U-SS	1/2	16	40	23.8	10.4	19.1	24	11.9
M4-TSW18M-U-SS	1/4	18	40.1	26	11.2	14.2	27	7.1
M12-TSW28M-U-SS	3/4	28	55.5	40	20	19.1	41	15.7
M20-TSW38M-U-SS	1 1/4	38	68.3	50.8	22	23.9	52	28.6

NPT外螺纹-卡套管对接焊 (Tube BW)

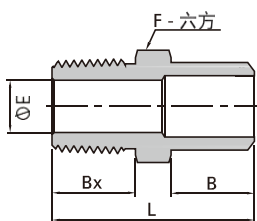

型号	接口类型和尺寸			尺寸 mm				
	端口1 MNPT	端口2 Tube管对接		L	B	Bx	F	E
	in.	外径 in.	壁厚 in.					
M4-TBW4*065-U-SS	1/4	1/4	0.065	29.7	9.7	14.2	14.3	7.1
M8-TBW4*065-U-SS	1/2	1/4	0.065	36.8	9.7	19.1	22.2	11.9
M4-TBW6*095-U-SS	1/4	3/8	0.095	29.7	9.7	14.2	14.3	7.1
M8-TBW6*095-U-SS	1/2	3/8	0.095	36.8	9.7	19.1	22.2	11.9
M4-TBW8*095-U-SS	1/4	1/2	0.095	34.3	14.2	14.2	14.3	7.1
M8-TBW8*095-U-SS	1/2	1/2	0.095	41.4	14.2	19.1	22.2	11.9
M4-TBW10*109-U-SS	1/4	5/8	0.109	34.8	14.2	14.2	17.5	7.1
M8-TBW10*109-U-SS	1/2	5/8	0.109	41.4	14.2	19.1	22.2	11.9
M4-TBW12*120-U-SS	1/4	3/4	0.12	40.1	19.1	14.2	20.6	7.1
M8-TBW12*120-U-SS	1/2	3/4	0.12	46.2	19.1	19.1	22.2	11.9
M4-TBW16*134-U-SS	1/4	1	0.134	42.9	19.1	14.2	27	7.1
M8-TBW16*134-U-SS	1/2	1	0.134	47.8	19.1	19.1	27	11.9

型号	接口类型和尺寸			尺寸 mm				
	端口1 MNPT	端口2 Tube管对接		L	B	Bx	F	E
	in.	外径 mm	壁厚 mm					
M4-TBW12M*2.2-U-SS	1/4	12	2.2	34.3	14.2	14.2	14	7.1
M8-TBW12M*2.2-U-SS	1/2	12	2.2	41.1	14.2	19.1	22	11.9
M4-TBW14M*2.5-U-SS	1/4	14	2.5	34.3	14.2	14.2	15	7.1
M8-TBW14M*2.5-U-SS	1/2	14	2.5	41.4	14.2	19.1	22	11.9
M4-TBW15M*2.5-U-SS	1/4	15	2.5	34.8	14.2	14.2	16	7.1
M4-TBW16M*2.8-U-SS	1/4	16	2.8	35.6	14.2	14.2	18	7.1
M8-TBW16M*2.8-U-SS	1/2	16	2.8	41.1	14.2	19.1	22	11.9
M8-TBW20M*3-U-SS	1/2	20	3	46.2	19.1	19.1	22	11.9
M4-TBW22M*3-U-SS	1/4	22	3	41.2	19.1	14.2	24	7.1
M8-TBW22M*3-U-SS	1/2	22	3	46.1	19.1	19.1	24	11.9
M12-TBW25M*3.5-U-SS	3/4	25	3.5	47.8	19.1	19.1	27	15.7
M16-TBW25M*3.5-U-SS	1	25	3.5	54.9	19.1	23.9	35	22.4
M8-TBW28M*4-U-SS	1/2	28	4	54.2	21.4	19.1	30	11.9

NPT外螺纹-公称管对接焊 (Pipe BW)

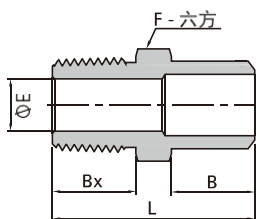

型号	接口类型和尺寸		尺寸 mm				
	端口1 MNPT in.	端口2 Pipe管对 焊 Sch80in.	L	B	Bx	F	E
M4-PBW4-U-SS	1/4	1/4	34.3	14.2	14.2	14.3	7.1
M8-PBW4-U-SS	1/2	1/4	41.3	14.2	19.1	22.2	7.7
M4-PBW6-U-SS	1/4	3/8	34.8	14.2	14.2	17.5	7.1
M8-PBW6-U-SS	1/2	3/8	41.3	14.2	19.1	22.2	10.7
M4-PBW8-U-SS	1/4	1/2	41.3	19.1	14.2	22.2	7.1
M8-PBW8-U-SS	1/2	1/2	46.2	19.1	19.1	22.2	11.9
M4-PBW12-U-SS	1/4	3/4	42.9	19.1	14.2	27	7.1
M8-PBW12-U-SS	1/2	3/4	47.8	19.1	19.1	27	11.9
M4-PBW16-U-SS	1/4	1	50	23.9	14.2	34.9	7.1
M8-PBW16-U-SS	1/2	1	54.9	23.9	19.1	34.9	11.9

NPT外螺纹-公称管承插焊 (Pipe SW)

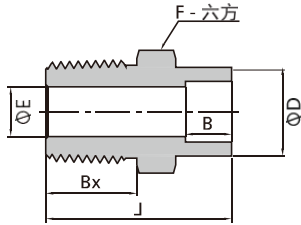

型号	接口类型和尺寸		尺寸mm					
	端口1 MNPT in.	端口2 Pipe 管插 焊 in.	L	D	B	Bx	F	E
M4-PSW4-U-SS	1/4	1/4	35.2	22.4	9.9	14.2	23.8	7.1
M8-PSW4-U-SS	1/2	1/4	40	22.4	9.9	19.1	23.8	9.1
M6-PSW6-U-SS	3/8	3/8	38	26.2	9.9	14.2	27	9.7
M8-PSW6-U-SS	1/2	3/8	42.9	26.2	9.9	19.1	27	11.9
M6-PSW8-U-SS	3/8	1/2	40.3	31.8	9.9	14.2	33.3	9.7
M8-PSW8-U-SS	1/2	1/2	45.2	31.8	9.9	19.1	33.3	11.9
M8-PSW12-U-SS	1/2	3/4	54.3	37.3	13	19.1	38.1	11.9
M12-PSW12-U-SS	3/4	3/4	54.3	37.3	13	19.1	38.1	15.7
M12-PSW16-U-SS	3/4	1	55.8	47.2	13	19.1	47.6	15.7
M16-PSW16-U-SS	1	1	60.6	47.2	13	23.9	47.6	22.4

NPT内螺纹-卡套管对接焊 (Tube SW)

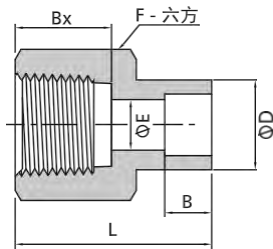

型号	接口类型和尺寸		尺寸 mm					
	端口1 FNPT in.	端口2 Tube管插 焊 in.	L	D	B	Bx	F	E
F2-TSW2-U-SS	1/8	1/8	21.1	7.4	2.5	10.4	14.3	2.3
F2-TSW4-U-SS	1/8	1/4	26.7	12.2	7.1	10.4	14.3	4.8
F4-TSW4-U-SS	1/4	1/4	30	12.2	7.1	15	19.1	4.8
F4-TSW6-U-SS	1/4	3/8	31.5	15.2	7.9	15	19.1	7.1
F6-TSW8-U-SS	3/8	1/2	34.5	18.5	9.7	15	22.2	10.4
F8-TSW8-U-SS	1/2	1/2	40.4	18.5	9.7	19.8	27	10.4
F12-TSW12-U-SS	3/4	3/4	43.9	26.4	11.2	20.6	33.3	16
F16-TSW16-U-SS	1	1	54.1	34.5	15.7	25.4	41.3	22.4

型号	接口类型和尺寸		尺寸 mm					
	端口1 FNPT in.	端口2 Tube管插 焊 mm	L	D	B	Bx	F	E
F4-TSW8M-U-SS	1/4	8	27	14.3	7.9	15	19	4.8
F4-TSW10M-U-SS	1/4	10	29	16.5	7.9	15	19	7.1
F4-TSW14M-U-SS	1/4	14	32	23.8	10	15	24	9.5
F12-TSW28M-U-SS	3/4	28	54.1	40	20	20.6	41	19.8

NPT内螺纹-卡套管对接焊 (Tube BW)

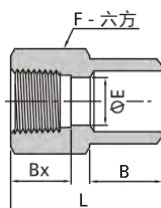

型号	接口类型和尺寸			尺寸 mm				
	端口1 FNPT	端口2 Tube管对焊		L	B	Bx	F	E
	in.	外径 in.	壁厚 in.					
F4-TBW4*065-U-SS	1/4	1/4	0.065	27.9	9.7	15	19.1	3
F6-TBW4*065-U-SS	3/8	1/4	0.065	29.5	9.7	15	22.2	3
F4-TBW6*095-U-SS	1/4	3/8	0.095	27.9	9.7	15	19.1	4.7
F6-TBW6*095-U-SS	3/8	3/8	0.095	29.5	9.7	15	22.2	4.7
F4-TBW8*095-U-SS	1/4	1/2	0.095	34	14.2	15	19.1	7.9
F6-TBW8*095-U-SS	3/8	1/2	0.095	34	14.2	15	22.2	7.9
F8-TBW8*095-U-SS	1/2	1/2	0.095	38.9	14.2	19.8	27	7.9

型号	接口类型和尺寸			尺寸 mm				
	端口1 FNPT	端口2 Tube管对焊		L	B	Bx	F	E
	in.	外径 mm	壁厚 mm					
F4-TBW14*2.5-U-SS	1/4	14	2.5	33	14.2	15	19	9
F8-TBW14*2.5-U-SS	1/2	14	2.5	38.9	14.2	19.8	27	9
F8-TBW20*3-U-SS	1/2	20	3	43.7	19.1	19.8	27	14
F8-TBW28*4-U-SS	1/2	28	4	49.8	23.9	19.8	30	15.7

NPT内螺纹-公称管对接焊 (Pipe BW)

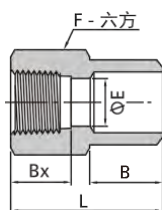

型号	接口类型和尺寸		尺寸 mm				
	端口1 FNPT in.	端口2 Pipe 管对焊 Sch80in.	L	B	Bx	F	E
F8-PBW4-U-SS	1/2	1/4	38.9	14.2	19.8	27	7.6
F8-PBW6-U-SS	1/2	3/8	38.9	14.2	19.8	27	10.7
F4-PBW8-U-SS	1/4	1/2	37.3	19.1	15	22.2	10.4
F8-PBW8-U-SS	1/2	1/2	43.7	19.1	19.8	27	13.9

NPT内螺纹-公称管承插焊 (Pipe SW)

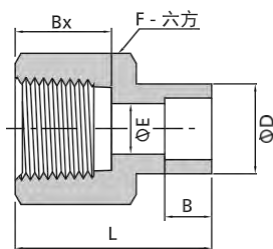

型号	接口类型和尺寸		尺寸 mm					
	端口1 FNPT in.	端口2 Pipe管 插焊 in.	L	D	B	Bx	F	E
F4-PSW4-U-SS	1/4	1/4	35.2	22.4	9.9	14.2	23.8	7.1
F8-PSW4-U-SS	1/2	1/4	40	22.4	9.9	19.1	23.8	9.1
F6-PSW6-U-SS	3/8	3/8	38	26.2	9.9	14.2	27	9.7
F8-PSW6-U-SS	1/2	3/8	42.9	26.2	9.9	19.1	27	11.9
F6-PSW8-U-SS	3/8	1/2	40.3	31.8	9.9	14.2	33.3	9.7
F8-PSW8-U-SS	1/2	1/2	45.2	31.8	9.9	19.1	33.3	11.9
F8-PSW12-U-SS	1/2	3/4	54.3	37.3	13	19.1	38.1	11.9
F12-PSW12-U-SS	3/4	3/4	54.3	37.3	13	19.1	38.1	15.7
F12-PSW16-U-SS	3/4	1	55.8	47.2	13	19.1	47.6	15.7
F16-PSW16-U-SS	1	1	60.6	47.2	13	23.9	47.6	22.4

NPT外螺纹-卡套管对接焊活接头 (Tube BW)

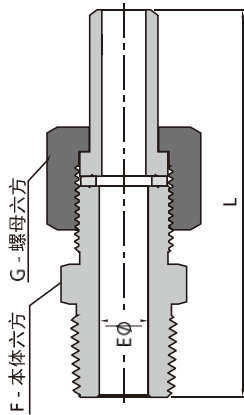

型号	接口类型和尺寸			尺寸 mm			
	端口1 MNPT	端口2 Tube管对接		L	F	G	E
		in.	外径 mm				
M2-TBW14M*2.5-UA-SS	1/8	14	2.5	69	19	22	4.8
M4-TBW6M*1.8-UA-SS	1/4	6	1.8	60	14	14	3
M4-TBW8M*1.8-UA-SS	1/4	8	1.8	73.2	14	16	4
M4-TBW10M*2.2-UA-SS	1/4	10	2.2	73.2	15	18	6
M4-TBW12M*2.2-UA-SS	1/4	12	2.2	73.2	18	22	7
M4-TBW14M*2.5-UA-SS	1/4	14	2.5	73.2	19	22	7.1
M4-TBW16M*2.8-UA-SS	1/4	16	2.8	73.2	22	25	7.1
M4-TBW18M*2.8-UA-SS	1/4	18	2.8	74.2	24	27	7.1
M6-TBW14M*2.5-UA-SS	3/8	14	2.5	73.2	19	22	9.7
M8-TBW12M*2.2-UA-SS	1/2	12	2.2	78	18	22	7
M8-TBW14M*2.5-UA-SS	1/2	14	2.5	78	19	22	9
M8-TBW16M*2.8-UA-SS	1/2	16	2.8	78	22	25	10
M8-TBW22M*3-UA-SS	1/2	22	3	82	30	32	11.9
M8-TBW25M*2.8-UA-SS	1/2	25	2.8	86	32	35	11.9
M16-TBW25M*3.5-UA-SS	1	25	3.5	103	35	35	17

公制内螺纹-卡套管对接焊活接头 (Tube BW)

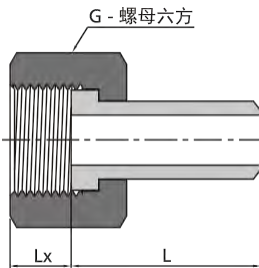

型号	接口类型和尺寸			尺寸 mm		
	端口 1 公制内螺 纹	端口2 Tube管插焊		L	G	Lx
		外径 mm	壁厚 mm			
FM12*1.5-TSW6M*1.8-UA-SS	M12x1.5	6	1.8	25	16	9
FM12*1.5-TSW8M*1.8-UA-SS	M12x1.5	8	1.8	30	16	9
FM14*1.5-TSW8M*1.8-UA-SS	M14x1.5	8	1.8	30	18	9
FM14*1.5-TSW10M*2.2-UA-SS	M14x1.5	10	2.2	30	18	9
FM16*1.5-TSW8M*1.8-UA-SS	M16x1.5	8	1.8	30	22	9
FM16*1.5-TSW10M*2.2-UA-SS	M16x1.5	10	2.2	30	22	9
FM16*1.5-TSW12M*2.2-UA-SS	M16x1.5	12	2.2	34	22	9
FM18*1.5-TSW10M*2.2-UA-SS	M18x1.5	10	2.2	34	22	10
FM18*1.5-TSW12M*2.2-UA-SS	M18x1.5	12	2.2	34	22	10
FM18*1.5-TSW14M*2.5-UA-SS	M18x1.5	14	2.5	34	22	10
FM20*1.5-TSW10M*2.2-UA-SS	M20x1.5	10	2.2	34	25	11
FM20*1.5-TSW12M*2.2-UA-SS	M20x1.5	12	2.2	34	25	11
FM20*1.5-TSW14M*2.5-UA-SS	M20x1.5	14	2.5	34	25	11
FM20*1.5-TSW15M*2.5-UA-SS	M20x1.5	15	2.5	34	25	11
FM20*1.5-TSW16M*2.8-UA-SS	M20x1.5	16	2.8	34	25	11
FM22*1.5-TSW14M*2.5-UA-SS	M22x1.5	14	2.5	34	27	11
FM22*1.5-TSW16M*2.8-UA-SS	M22x1.5	16	2.8	34	27	11
FM24*1.5-TSW16M*2.8-UA-SS	M24x1.5	16	2.8	34	30	11
FM24*1.5-TSW18M*2.8-UA-SS	M24x1.5	18	2.8	34	30	11
FM24*1.5-TSW20M*3-UA-SS	M24x1.5	20	3	34	30	11
FM27*2-TSW14M*2.5-UA-SS	M27x2	14	2.5	34	32	14
FM27*2-TSW16M*2.8-UA-SS	M27x2	16	2.8	34	32	14
FM27*2-TSW18M*2.8-UA-SS	M27x2	18	2.8	34	32	14
FM27*2-TSW20M*3-UA-SS	M27x2	20	3	40	32	14
FM27*2-TSW22M*3-UA-SS	M27x2	22	3	40	32	14
FM30*2-TSW22M*3-UA-SS	M30x2	22	3	40	35	18
FM30*2-TSW25M*3.5-UA-SS	M30x2	25	3.5	45	35	18
FM33*2-TSW28M*4-UA-SS	M33x2	28	4	45	41	18
FM36*2-TSW30M*4-UA-SS	M36x2	30	4	45	41	18

等径卡套弯通

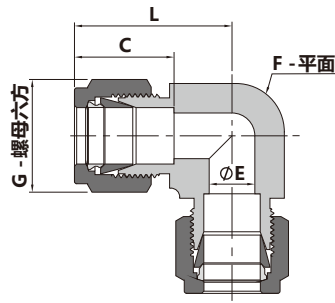

型号	接口类型和尺寸 卡套 in.	尺寸 mm				
		L	C	G	F	E
SS-L-1-A	1/16	17.8	8.6	7.9	9.5	1.3
SS-L-2-A	1/8	22.4	12.7	11.1	9.5	2.3
SS-L-3-A	3/16	25.4	13.7	12.7	12.7	3
SS-L-4-A	1/4	26.9	15.2	14.3	12.7	4.8
SS-L-5-A	5/16	28.7	16.3	15.9	14.3	6.4
SS-L-6-A	3/8	30.5	16.8	17.5	15.9	7.1
SS-L-8-A	1/2	36.1	22.9	22.2	20.6	10.4
SS-L-10-A	5/8	38.1	24.4	25.4	23.8	12.7
SS-L-12-A	3/4	39.9	24.4	28.6	27	15.7
SS-L-14-A	7/8	44.7	25.9	31.8	34.9	18.3
SS-L-16-A	1	49	31.2	38.1	34.9	22.4
SS-L-18-A	1 1/8	66.9	36.7	44.5	42.9	24.6
SS-L-20-A	1 1/4	66.5	41.1	47.6	42.9	27.7
SS-L-24-A	1 1/2	78	50	57.2	50.8	34

型号	接口类型和尺寸 卡套 mm	尺寸 mm				
		L	C	G	F	E
SS-L-3M-A	3	22.3	12.9	12	9.5	2.4
SS-L-4M-A	4	25.4	13.7	12	12.7	2.4
SS-L-6M-A	6	27	15.3	14	12.7	4.8
SS-L-8M-A	8	28.8	16.2	16	14.3	6.4
SS-L-10M-A	10	31.5	17.2	19	17.5	7.9
SS-L-12M-A	12	36	22.8	22	20.6	9.5
SS-L-14M-A	14	38	24.4	25	23.8	11
SS-L-15M-A	15	38	24.4	25	23.8	11.9
SS-L-16M-A	16	38	24.4	25	23.8	12.7
SS-L-18M-A	18	39.8	24.4	30	27	15.1
SS-L-20M-A	20	44.6	26	32	34.9	15.9
SS-L-22M-A	22	44.6	26	32	34.9	18.3
SS-L-25M-A	25	49.1	31.3	38	34.9	21.8
SS-L-28M-A	28	64	36.6	46	42.9	21.8
SS-L-30M-A	30	69.9	39.6	50	42.9	26.2
SS-L-32M-A	32	72.3	42	50	42.9	28.6
SS-L-38M-A	38	84	49.4	60	50.8	33.7

变径卡套弯通

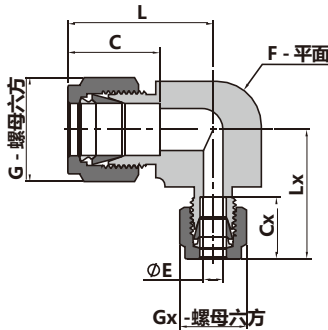

型号	接口类型和尺寸		尺寸 mm							
	端口1 卡套 in.	端口2 卡套 in.	L	C	G	F	E	Cx	Gx	Lx
A3-A2-L-SS	3/16	1/8	25.4	13.7	12.7	12.7	2.3	12.7	11.1	24.7
A4-A2-L-SS	1/4	1/8	26.9	15.2	14.3	12.7	2.3	12.7	11.1	25.4
A5-A2-L-SS	5/16	1/8	29.7	16.3	15.9	14.3	2.3	12.7	11.1	26.4
A5-A4-L-SS	5/16	1/4	29.7	16.3	15.9	14.3	4.8	15.2	14.3	29
A6-A2-L-SS	3/8	1/8	30.5	16.8	17.5	15.9	2.3	12.7	11.1	26.4
A6-A4-L-SS	3/8	1/4	30.5	16.8	17.5	15.9	4.8	15.2	14.3	29
A6-A5-L-SS	3/8	5/16	30.5	16.8	17.5	15.9	6.4	16.3	15.9	29.7
A8-A4-L-SS	1/2	1/4	36.1	22.9	22.2	20.6	4.8	15.2	14.3	32.2
A8-A5-L-SS	1/2	5/16	36.1	22.9	22.2	20.6	6.4	16.3	15.9	32.5
A8-A6-L-SS	1/2	3/8	36.1	22.9	22.2	20.6	7.1	16.8	17.5	33.6
A10-A6-L-SS	5/8	3/8	38.1	24.4	25.4	23.8	7.1	16.8	17.5	35.6
A10-A8-L-SS	5/8	1/2	38.1	24.4	25.4	23.8	10.4	22.9	22.2	38.1
A12-A4-L-SS	3/4	1/4	39.9	24.4	28.6	27	4.8	15.2	14.3	35.9
A12-A6-L-SS	3/4	3/8	39.9	24.4	28.6	27	7.1	16.8	17.5	37.4
A12-A8-L-SS	3/4	1/2	39.9	24.4	28.6	27	10.4	22.9	22.2	39.9
A14-A4-L-SS	7/8	1/4	44.7	25.9	31.8	34.9	4.8	15.2	14.3	40.7
A16-A8-L-SS	1	1/2	49	31.2	38.1	34.9	10.4	22.9	22.2	44.4
A16-A12-L-SS	1	3/4	49	31.2	38.1	34.9	15.7	24.4	28.6	47.1

型号	接口类型和尺寸		尺寸 mm							
	端口1 卡套 mm	端口2 卡套 mm	L	C	G	F	E	Cx	Gx	Lx
A8M-A6M-L-SS	8	6	28.8	16.2	16	14.3	4.8	15.3	14	27.9
A10M-A8M-L-SS	10	8	31.5	17.2	19	17.5	6.4	16.2	16	30.5
A12M-A8M-L-SS	12	8	36	22.8	22	20.6	6.4	16.2	16	32.6
A14M-A8M-L-SS	14	8	38.8	24.4	25	23.8	6.4	16.2	16	34.7
A14M-A10M-L-SS	14	10	38.8	24.4	25	23.8	7.9	17.2	19	35.5

等径穿板卡套弯通

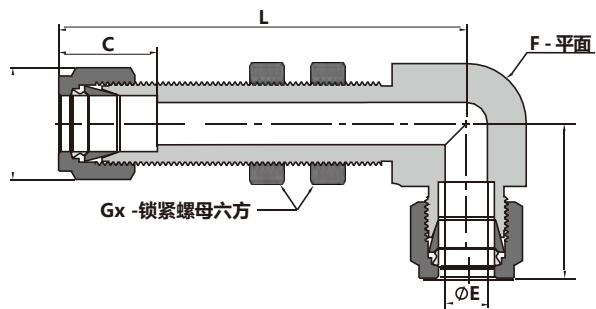

型号	接口类型 和尺寸	尺寸 mm							面板 孔尺寸	最大 面板 厚度
	卡套 in.	L	C	E	G	F	Lx	Gx		
BA2-A2-L-SS	1/8	49	12.7	2.3	11.1	9.5	22.4	12.7	8.3	15.2
BA3-A3-L-SS	3/16	51.6	13.7	3	12.7	12.7	25.4	14.3	9.9	15.5
BA4-A4-L-SS	1/4	53.3	15.2	4.8	14.3	12.7	26.9	15.9	11.5	15.5
BA5-A5-L-SS	5/6	58.4	16.3	6.4	15.9	15.9	28.7	17.5	13.1	18.8
BA6-A6-L-SS	3/8	59.9	16.8	7.1	15.7	15.9	30.5	19.1	14.7	18.8
BA8-A8-L-SS	1/2	67.8	22.9	10.4	22.2	20.6	36.1	23.8	19.4	18.8
BA10-A10-L-SS	5/8	71.6	24.4	12.7	25.4	23.8	38.1	27	22.6	12.7
BA12-A12-L-SS	3/4	78.2	24.4	12.7	28.6	27	39.9	30.2	25	16.8

卡套-NPT外螺纹弯通

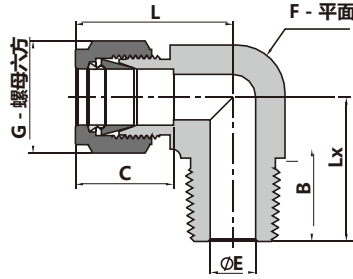

注：RC螺纹尺寸与NPT螺纹相同，对应型号中只需把M变为MRC，如A6M-MRC4-L-SS

型号	接口类型和尺寸		尺寸 mm						
	端口1 卡套 mm	端口2 MNPT in.	L	C	G	F	E	B	LX
A1-M1-L-SS	1/16	1/16	19.1	8.6	7.9	11.1	1.3	9.7	17.8
A1-M2-L-SS	1/16	1/8	19.1	8.6	7.9	11.1	1.3	9.7	17.8
A2-M1-L-SS	1/8	1/16	23.6	12.7	11.1	11.1	2.4	9.7	17.8
A2-M2-L-SS	1/8	1/8	23.6	12.7	11.1	11.1	2.4	9.7	17.8
A2-M4-L-SS	1/8	1/4	24.6	12.7	11.1	12.7	2.4	14.2	23.4
A3-M2-L-SS	3/16	1/8	25.4	13.7	12.7	12.7	3	9.7	18.8
A3-M4-L-SS	3/16	1/4	25.4	13.7	12.7	12.7	3	14.2	23.4
A4-M1-L-SS	1/4	1/16	26.9	15.2	14.3	12.7	3	9.7	18.8
A4-M2-L-SS	1/4	1/8	26.9	15.2	14.3	12.7	4.8	9.7	18.8
A4-M4-L-SS	1/4	1/4	26.9	15.2	14.3	12.7	4.8	14.2	23.4
A4-M6-L-SS	1/4	3/8	29.7	15.2	14.3	17.5	4.8	14.2	26.2
A4-M8-L-SS	1/4	1/2	31.8	15.2	14.3	20.6	4.8	19.1	33
A5-M2-L-SS	5/16	1/8	28.7	16.3	15.9	14.3	4.8	9.7	19.8
A5-M4-L-SS	5/16	1/4	28.7	16.3	15.9	14.3	6.4	14.2	24.4
A5-M6-L-SS	5/16	3/8	30.5	16.3	15.9	17.5	6.4	14.2	26.2
A6-M2-L-SS	3/8	1/8	30.5	16.8	17.5	15.9	4.8	9.7	20.8
A6-M4-L-SS	3/8	1/4	30.5	16.8	17.5	15.9	7.1	14.2	25.4
A6-M6-L-SS	3/8	3/8	31.2	16.8	17.5	17.5	7.1	14.2	26.2
A6-M8-L-SS	3/8	1/2	33.3	16.8	17.5	20.6	7.1	19.1	33
A6-M12-L-SS	3/8	3/4	37.1	16.8	17.5	27	7.1	19.1	36.8
A8-M4-L-SS	1/2	1/4	36.1	22.9	22.2	20.6	7.1	14.2	28.2
A8-M6-L-SS	1/2	3/8	36.1	22.9	22.2	20.6	9.7	14.2	28.2
A8-M8-L-SS	1/2	1/2	36.1	22.9	22.2	20.6	10.4	19.1	33
A8-M12-L-SS	1/2	3/4	39.9	22.9	22.2	27	10.4	19.1	36.8
A10-M6-L-SS	5/8	3/8	38.1	24.4	25.4	23.8	9.7	14.2	30.2
A10-M8-L-SS	5/8	1/2	38.1	24.4	25.4	23.8	11.9	19.1	35.1
A10-M12-L-SS	5/8	3/4	39.9	24.4	25.4	27	12.7	19.1	36.8
A12-M8-L-SS	3/4	1/2	39.9	24.4	28.6	27	11.9	19.1	36.8
A12-M12-L-SS	3/4	3/4	39.9	24.4	28.6	27	15.7	19.1	36.8
A14-M12-L-SS	7/8	3/4	44.7	25.9	31.8	34.9	15.7	19.1	41.7
A16-M12-L-SS	1	3/4	49	31.2	38.1	34.9	15.7	19.1	41.7
A16-M16-L-SS	1	1	49	31.2	38.1	34.9	22.4	23.9	46.5
A20-M20-L-SS	1.25	1.25	66.5	41.1	47.6	42.9	27.7	23.9	52.4
A24-M24-L-SS	11/2	11/2	78	50	57.2	50.8	34	26.2	60.5

型号	接口类型和尺寸		尺寸 mm						
	端口1 卡套 in.	端口2 MNPT in.	L	C	G	F	E	B	LX
A3M-M2-L-SS	3	1/8	23.6	12.9	12	11.1	2.4	9.7	17.8
A3M-M4-L-SS	3	1/4	24.6	12.9	12	12.7	2.4	14.2	23.4
A4M-M2-L-SS	4	1/8	25.4	13.7	12	12.7	2.4	9.7	18.8
A4M-M4-L-SS	4	1/4	25.4	13.7	12	12.7	2.4	14.2	23.4
A6M-M2-L-SS	6	1/8	27	15.3	14	12.7	4.8	9.7	18.8
A6M-M4-L-SS	6	1/4	27	15.3	14	12.7	4.8	14.2	23.4
A6M-M6-L-SS	6	3/8	29.8	15.3	14	17.5	4.8	14.2	26.2
A6M-M8-L-SS	6	1/2	31.8	15.3	14	20.6	4.8	19.1	33
A8M-M2-L-SS	8	1/8	28.8	16.2	16	14.3	4.8	9.7	19.8
A8M-M4-L-SS	8	1/4	28.8	16.2	16	14.3	6.4	14.2	24.4
A8M-M6-L-SS	8	3/8	30.6	16.2	16	17.5	6.4	14.2	26.2
A8M-M8-L-SS	8	1/2	32.6	16.2	16	20.6	6.4	19.1	33
A10M-M2-L-SS	10	1/8	31.5	17.2	19	17.5	4.8	9.7	21.6
A10M-M4-L-SS	10	1/4	31.5	17.2	19	17.5	7.1	14.2	26.2
A10M-M6-L-SS	10	3/8	31.5	17.2	19	17.5	7.9	14.2	26.2
A10M-M8-L-SS	10	1/2	33.5	17.2	19	20.6	7.9	19.1	33
A12M-M2-L-SS	12	1/8	36	22.8	22	20.6	4.8	9.7	23.6
A12M-M4-L-SS	12	1/4	36	22.8	22	20.6	7.1	14.2	28.2
A12M-M6-L-SS	12	3/8	36	22.8	22	20.6	9.5	14.2	28.2
A12M-M8-L-SS	12	1/2	36	22.8	22	20.6	9.5	19.1	33
A12M-M12-L-SS	12	3/4	39.8	22.8	22	27	9.5	19.1	36.8
A15M-M8-L-SS	15	1/2	38	24.4	25	23.8	11.9	19.1	35.1
A16M-M4-L-SS	16	1/4	38	24.4	25	23.8	7.1	14.2	30.2
A16M-M6-L-SS	16	3/8	38	24.4	25	23.8	9.5	14.2	30.2
A16M-M8-L-SS	16	1/2	38	24.4	25	23.8	11.9	19.1	35.1
A16M-M12-L-SS	16	3/4	39.8	24.4	25	27	12.7	19.1	36.8
A18M-M8-L-SS	18	1/2	39.8	24.4	30	27	11.9	19.1	36.8
A18M-M12-L-SS	18	3/4	39.8	24.4	30	27	15.1	19.1	36.8
A20M-M8-L-SS	20	1/2	44.6	26	32	34.9	11.9	19.1	41.7
A20M-M12-L-SS	20	3/4	44.6	26	32	34.9	15.9	19.1	41.7
A22M-M12-L-SS	22	3/4	44.6	26	32	34.9	15.9	19.1	41.7
A22M-M16-L-SS	22	1	44.6	26	32	34.9	18.3	23.9	46.5
A25M-M12-L-SS	25	3/4	49.1	31.3	38	34.9	15.9	19.1	41.7
A25M-M16-L-SS	25	1	49.1	31.3	38	34.9	21.8	23.9	46.5
A30M-M20-L-SS	30	11/4	69.9	39.6	50	42.9	26.2	23.9	53.1
A32M-M20-L-SS	32	11/4	72.3	42	50	42.9	27.8	23.9	53.1
A38M-M24-L-SS	38	11/2	84	49.4	60	50.8	33.7	26.2	60.4

卡套-NPT外螺纹45°弯通

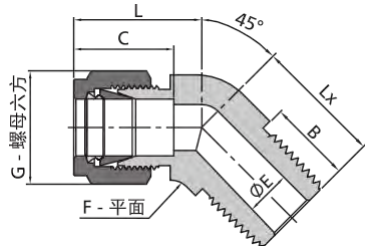

注：RC螺纹尺寸与NPT螺纹相同，对应型号中只需把M变为MRC，如A6M-MRC4-L1-SS

型号	接口类型和尺寸		尺寸 mm							
	端口1 卡套 in.	端口2 MNPT in.	L	C	G	F	E	B	LX	
A1-M1-L1-SS	1/16	1/16	20.8	8.6	7.9	11.1	1.3	9.7	16.8	
A2-M2-L1-SS	1/8	1/8	20.8	12.7	11.1	11.1	2.3	9.7	16.8	
A3-M2-L1-SS	3/16	1/8	21.6	13.7	12.7	11.1	3	9.7	14.7	
A4-M2-L1-SS	1/4	1/8	24.6	15.2	14.3	12.7	4.8	9.7	16.5	
A4-M4-L1-SS	1/4	1/4	24.6	15.2	14.3	12.7	4.8	14.2	21.1	
A5-M2-L1-SS	5/16	1/8	24	16.3	15.9	14.3	4.8	9.7	16.8	
A6-M2-L1-SS	3/8	1/8	27.9	16.8	17.5	15.9	4.8	9.7	18.3	
A6-M4-L1-SS	3/8	1/4	27.9	16.8	17.5	15.9	7.1	14.2	22.9	
A6-M6-L1-SS	3/8	3/8	29.2	16.8	17.5	20.6	7.1	14.2	24.1	
A8-M6-L1-SS	1/2	3/8	32	22.9	22.2	20.6	9.7	14.2	24.1	
A10-M8-L1-SS	5/8	1/2	30.7	24.4	25.4	23.8	11.9	19.1	29.7	
A12-M12-L1-SS	3/4	3/4	34	24.4	28.6	27	15.7	19.1	31	
A14-M12-L1-SS	7/8	3/4	40.4	25.9	31.8	31.8	15.7	19.1	32.3	
A16-M16-L1-SS	1	1	40.4	31.2	38.1	34.9	22.4	23.9	37.8	

型号	接口类型和尺寸		尺寸 mm							
	端口1 卡套 mm	端口2 MNPT in.	L	C	G	F	E	B	LX	
A6M-M2-L1-SS	6	1/8	23.4	15.3	14	12.7	4.8	9.7	16.8	
A6M-M4-L1-SS	6	1/4	23.4	15.3	14	12.7	4.8	14.2	21.8	
A8M-M2-L1-SS	8	1/8	24.3	16.2	16	15.9	4.8	9.7	16.8	
A10M-M4-L1-SS	10	1/4	26.6	17.2	19	17.5	7.9	14.2	24.1	
A12M-M6-L1-SS	12	3/8	29.1	22.8	22	20.6	9.5	14.2	24.1	
A12M-M8-L1-SS	12	1/2	30.7	22.8	22	20.6	9.5	19.1	29.7	
A16M-M8-L1-SS	16	1/2	30.7	24.4	25	23.8	11.9	19.1	29.7	

卡套-SAE/MS外螺纹可调弯通

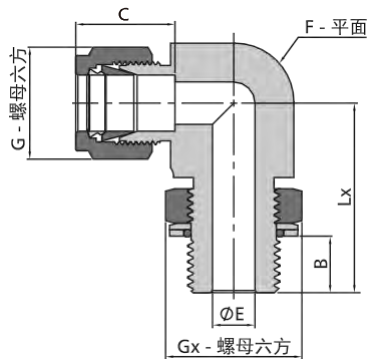

型号	接口类型和尺寸		尺寸 mm								
	端口1 卡套 in.	端口2 可调节 SAE/MS外 螺纹 in.	L	B	C	G	E	F	LX	GX	
A4-MUNF7/16-20-LP-SS	1/4	7/16-20	28.4	9.9	15.2	14.3	4.8	12.7	27	14.3	
A4-MUNF9/16-18-LP-SS	1/4	9/16-18	30.5	11.2	15.2	14.3	4.8	15.9	32.3	17.5	
A5-MUNF1/2-20-LP-SS	5/16	1/2-20	30.2	9.9	16.3	15.9	5.8	14.3	29.5	15.9	
A6-MUNF7/16-20-LP-SS	3/8	7/16-20	33.3	9.9	16.8	17.5	5.1	15.9	31.5	14.3	
A6-MUNF9/16-18-LP-SS	3/8	9/16-18	32	11.2	16.8	17.5	7.1	15.9	32.3	17.5	
A6-MUNF3/4-16-LP-SS	3/8	3/4-16	34.8	12.7	16.8	17.5	7.1	20.6	37.8	22.2	
A8-MUNF9/16-18-LP-SS	1/2	9/16-18	37.6	11.2	22.9	22.2	7.1	20.6	37.5	17.5	
A8-MUNF3/4-16-LP-SS	1/2	3/4-16	37.6	12.7	22.9	22.2	10.4	20.6	37.8	22.2	
A10-MUNF7/8-14-LP-SS	5/8	7/8-14	39.6	14.2	24.4	25.4	12.7	23.8	43.4	25.4	
A12-MUNF11/16-12-LP-SS	3/4	11/16-12	41.4	16.8	24.4	28.6	15.7	27	48.8	31.8	
A14-MUNF13/16-12-LP-SS	7/8	13/16-12	43.2	16.8	25.9	31.8	18.3	31.8	50.5	34.9	
A16-MUNF15/16-12-LP-SS	1	15/16-12	50.5	16.8	31.2	38.1	22.4	34.9	53.6	38.1	
A20-MUNF15/8-12-LP-SS	1 1/4	15/8-12	67.8	16.8	41.1	47.6	27.7	42.9	58.2	47.6	
A24-MUNF17/8-12-LP-SS	1 1/2	17/8-12	78	16.8	50	57.2	34	50.8	60.5	54	

卡套-ISO平行外螺纹可调弯通

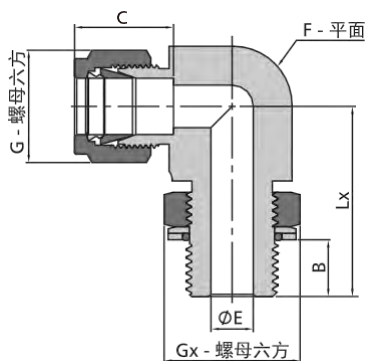

型号	接口类型和尺寸		尺寸 mm							
	端口1 卡套 in.	端口2 可调节ISO平螺纹 in.	L	B	C	G	E	F	LX	GX
A4-MG2-LP-SS	1/4	1/8	26.9	6.6	15.2	14.3	4.1	12.7	26.4	14.3
A4-MG4-LP-SS	1/4	1/4	29	9	15.2	14.3	4.8	15.9	32.3	19.1
A6-MG4-LP-SS	3/8	1/4	30.5	9	16.8	17.5	5.8	15.9	32.3	19.1
A6-MG6-LP-SS	3/8	3/8	33.3	9.4	16.8	17.5	7.1	20.6	37.1	22.2
A8-MG4-LP-SS	1/2	1/4	36.1	9	22.9	22.2	5.8	20.6	35.1	19.1
A8-MG6-LP-SS	1/2	3/8	36.1	9.4	22.9	22.2	7.9	20.6	37.1	22.2
A8-MG8-LP-SS	1/2	1/2	38.1	13	22.9	22.2	10.4	23.8	43.4	27
A10-MG8-LP-SS	5/8	1/2	38.1	13	24.4	25.4	11.9	23.8	43.4	27
A12-MG8-LP-SS	3/4	1/2	39.9	13	24.4	28.6	11.9	27	45.2	27
A12-MG12-LP-SS	3/4	3/4	39.9	13	24.4	28.6	15.7	27	48.8	34.9
A16-MG12-LP-SS	1	3/4	49	13	31.2	38.1	15.7	34.9	53.3	34.9
A16-MG16-LP-SS	1	1	49	13.2	31.2	38.1	19.8	34.9	53.6	41.3

型号	接口类型和尺寸		尺寸 mm							
	端口1 卡套 mm	端口2 可调节ISO平螺纹 in.	L	B	C	G	E	F	LX	GX
A6M-MG2-LP-SS	6	1/8	27	6.6	15.3	14	4	12.7	26.4	14.3
A6M-MG4-LP-SS	6	1/4	29	9	15.3	14	4.8	15.9	32.3	19.1
A8M-MG2-LP-SS	8	1/8	28.8	6.6	16.2	16	4	14.3	27.4	14.3
A8M-MG4-LP-SS	8	1/4	29.9	9	16.2	16	5.9	15.9	32.2	19.1
A10M-MG4-LP-SS	10	1/4	33.5	9	17.2	19	5.9	20.6	35	19.1
A10M-MG6-LP-SS	10	3/8	33.5	9.4	17.2	19	7.9	20.6	37.1	22.2
A12M-MG4-LP-SS	12	1/4	36	9	22.8	22	5.9	20.6	35	19.1
A12M-MG6-LP-SS	12	3/8	36	9.4	22.8	22	7.9	20.6	37.1	22.2
A12M-MG8-LP-SS	12	1/2	38	13	22.8	22	9.5	23.8	43.4	27
A12M-MG12-LP-SS	12	3/4	39.8	13	22.8	22	9.5	27	48.8	34.9

卡套-NPT内螺纹弯通

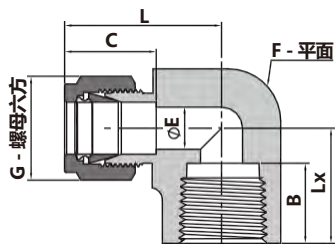

注：RC螺纹尺寸与NPT螺纹相同，对应型号中只需把F变为FRC，如A6M-FRC4-L-SS

型号	接口类型和尺寸		尺寸 mm						
	端口1 卡套 in.	端口2 MNPT in.	L	B	C	G	E	F	Lx
A1-F1-L-SS	1/16	1/16	18	9.9	8.6	7.9	1.3	11.1	14.2
A1-F2-L-SS	1/16	1/8	20.6	10.4	8.6	7.9	1.3	14.3	19.1
A2-F2-L-SS	1/8	1/8	24.6	10.4	12.7	11.1	2.3	12.7	19.1
A2-F4-L-SS	1/8	1/4	27.4	15	12.7	11.1	2.3	17.5	22.4
A3-F2-L-SS	3/16	1/8	25.4	10.4	13.7	12.7	3	12.7	19.1
A4-F2-L-SS	1/4	1/8	26.9	10.4	15.2	14.3	4.8	12.7	19.1
A4-F4-L-SS	1/4	1/4	29.7	15	15.2	14.3	4.8	17.5	22.4
A4-F6-L-SS	1/4	3/8	31.8	15	15.2	14.3	4.8	20.6	22.4
A4-F8-L-SS	1/4	1/2	34.5	19.8	15.2	14.3	4.8	25.4	28.4
A5-F2-L-SS	5/16	1/8	28.7	10.4	16.3	15.9	6.4	14.3	19.1
A5-F4-L-SS	5/16	1/4	30.5	15	16.3	15.9	6.4	17.5	22.4
A6-F2-L-SS	3/8	1/8	30.5	10.4	16.8	17.5	7.1	15.9	19.1
A6-F4-L-SS	3/8	1/4	31.2	15	16.8	17.5	7.1	17.5	22.4
A6-F6-L-SS	3/8	3/8	33.3	15	16.8	17.5	7.1	20.6	22.4
A6-F8-L-SS	3/8	1/2	36.1	19.8	16.8	17.5	7.1	25.4	28.4
A8-F4-L-SS	1/2	1/4	36.1	15	22.9	22.2	10.4	20.6	22.4
A8-F6-L-SS	1/2	3/8	36.1	15	22.9	22.2	10.4	20.6	22.4
A8-F8-L-SS	1/2	1/2	38.9	19.8	22.9	22.2	10.4	25.4	28.4
A10-F6-L-SS	5/8	3/8	38.1	15	24.4	25.4	12.7	23.8	22.4
A10-F8-L-SS	5/8	1/2	39.9	19.8	24.4	25.4	12.7	27	28.4
A12-F8-L-SS	3/4	1/2	39.9	19.8	24.4	28.6	15.7	27	28.4
A12-F12-L-SS	3/4	3/4	44.7	20.6	24.4	28.6	15.7	34.9	31.8
A14-F12-L-SS	7/8	3/4	44.7	20.6	25.9	31.8	18.3	34.9	31.8
A16-F12-L-SS	1	3/4	49	20.6	31.2	38.1	22.4	34.9	31.8
A16-F16-L-SS	1	1	53.6	26.9	31.2	38.1	22.4	42.9	38.1

型号	接口类型和尺寸		尺寸 mm						
	端口1 卡套 mm	端口2 MNPT in.	L	B	C	G	E	F	Lx
A6M-F2-L-SS	6	1/8	27	10.4	15.3	14	4.8	12.7	19
A6M-F4-L-SS	6	1/4	29.8	15	15.3	14	4.8	17.5	22.4
A8M-F2-L-SS	8	1/8	28.8	10.4	16.2	16	6.4	14.3	19.1
A8M-F4-L-SS	8	1/4	30.6	15	16.2	16	6.4	17.5	22.4
A10M-F4-L-SS	10	1/4	33.5	15	17.2	19	7.9	20.6	22.4
A10M-F6-L-SS	10	3/8	33.5	15	17.2	19	7.9	20.6	22.4
A10M-F8-L-SS	10	1/2	36.6	19.8	17.2	19	7.9	25.4	28.5
A12M-F4-L-SS	12	1/4	36	15	22.8	22	9.5	20.6	22.4
A12M-F6-L-SS	12	3/8	36	15	22.8	22	9.5	20.6	22.4
A12M-F8-L-SS	12	1/2	38.8	19.8	22.8	22	9.5	25.4	28.4
A16M-F6-L-SS	16	3/8	39.5	15	24.4	25	12.7	27	23.6
A16M-F8-L-SS	16	1/2	39.5	19.8	24.4	25	12.7	27	28.5

NPT外螺纹弯通

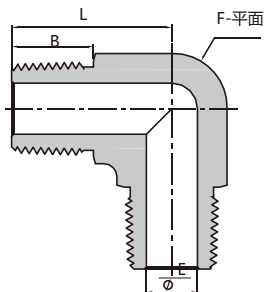

型号	接口类型和尺寸		尺寸 mm			
	端口 MNPT in.		L	F	B	E
M1-L-SS	1/16		17	9.5	9.7	3
M2-L-SS	1/8		22.4	11.1	9.7	4.8
M4-L-SS	1/4		26.7	12.7	14.2	7.1
M6-L-SS	3/8		29.7	17.5	14.2	9.6
M8-L-SS	1/2		36.8	20.6	19.1	11.9
M12-L-SS	3/4		40.4	27	19.1	15.7
M16-L-SS	1		50	34.9	23.9	22.4

NPT内螺纹弯通

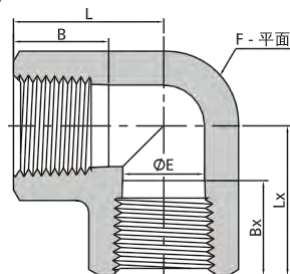

型号	接口类型和尺寸		尺寸 mm					
	端口1 FNPT in.	端口2 FNPT in.	L	F	B	E	Lx	Bx
F1-L-SS	1/16	1/16	21.8	11.1	9.9	4.8	21.8	9.9
F2-F1-L-SS	1/8	1/16	26.4	12.7	10.4	4.8	26.4	9.9
F2-L-SS	1/8	1/8	26.4	12.7	10.4	7.1	26.4	10.4
F4-F2-L-SS	1/4	1/8	29.7	17.5	15	7.1	29.7	10.4
F4-L-SS	1/4	1/4	29.7	17.5	15	10.4	29.7	15
F6-L-SS	3/8	3/8	36.1	20.6	15	12.7	36.1	15
F8-L-SS	1/2	1/2	39.6	25.4	19.8	17.1	39.6	19.8
F12-L-SS	3/4	3/4	48.8	31.8	20.6	22.4	48.8	20.6
F16-L-SS	1	1	48.5	42.9	25.4	28.1	48.5	25.4
F20-L-SS	1 1/4	1 1/4	59.8	50.8	25.4	27.7	59.8	25.4

NPT外螺纹-卡套管承插焊弯通 (Tube SW)

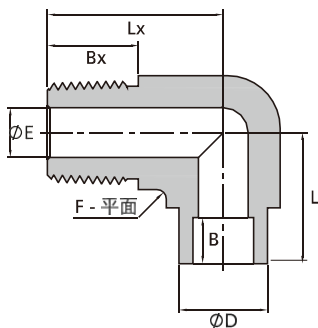

型号	接口类型和尺寸		尺寸 mm						
	端口1 MNPT in.	端口2 Tube管插焊 in.	L	Lx	D	B	Bx	F	E
M4-TSW4-L-SS	1/4	1/4	20.1	26.7	14.7	7.1	14.2	12.7	4.8
M4-TSW6-L-SS	1/4	3/8	26.4	26.7	14.7	7.9	14.2	12.7	7.1
M6-TSW6-L-SS	3/8	3/8	24.6	29.7	20.2	7.9	14.2	17.5	7.1
M8-TSW6-L-SS	1/2	3/8	25.9	36.8	23.8	7.9	19.1	20.6	7.1
M8-TSW8-L-SS	1/2	1/2	27.4	36.8	23.8	9.7	19.1	20.6	10.4
M12-TSW12-L-SS	3/4	3/4	38.9	39.6	26.4	11.2	19.1	27	15.7

NPT内螺纹-卡套管承插焊弯通 (Tube SW)

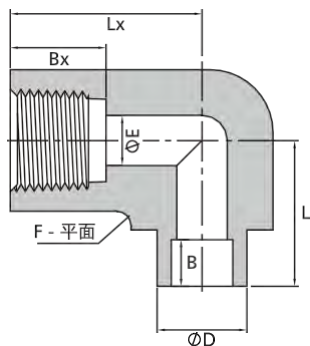

型号	接口类型和尺寸		尺寸 mm						
	端口1 FNPT in.	端口2 Tube管插焊 in.	L	Lx	D	B	Bx	F	E
F4-TSW4-L-SS	1/4	1/4	22.9	29.7	20.2	7.1	15	17.5	4.8
F4-TSW6-L-SS	1/4	3/8	25.1	29.7	20.2	7.9	15	17.5	7.1
F8-TSW6-L-SS	1/2	3/8	28.7	39.6	29.3	7.9	19.8	25.4	7.1
F8-TSW8-L-SS	1/2	1/2	30.2	39.6	29.3	9.7	19.8	25.4	10.4

卡套管承插焊弯通 (Tube SW)

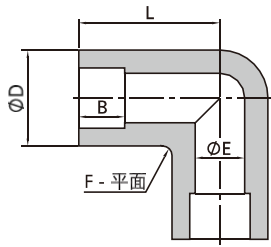

型号	接口类型和尺寸		尺寸 mm			
	Tube管插焊 mm	L	D	B	F	E
TSW10M-L-SS	10	24.6	16.5	7.9	14.3	7.4
TSW12M-L-SS	12	29.7	20.2	9.7	17.5	9.5
TSW14M-L-SS	14	31.7	23.8	10	20.6	10.4
TSW16M-L-SS	16	34.7	23.8	10.4	20.6	12.7

型号	接口类型和尺寸		尺寸 mm			
	Tube管插焊 in.	L	D	B	F	E
TSW4-L-SS	1/4	19.1	12.2	7.1	4.8	4.8
TSW6-L-SS	3/8	22.4	15.2	7.9	7.1	7.1
TSW8-L-SS	1/2	26.9	18.5	9.7	10.4	10.4
TSW10-L-SS	5/8	30.2	23.4	10.4	12.7	12.7
TSW12-L-SS	3/4	33.3	26.4	11.2	16	16
TSW14-L-SS	7/8	35.5	31.5	12.7	18.8	18.8
TSW16-L-SS	1	36.6	34.5	15.7	22.4	22.4

卡套管对接焊弯通 (Tube BW)

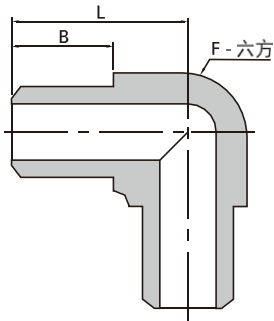

型号	接口类型和尺寸		尺寸 mm		
	端口 Tube管对接		L	B	F
	外径	壁厚			
TBW4*065-L-SS	1/4	0.065	16.3	9.7	9.5
TBW6*095-L-SS	3/8	0.095	18	9.7	11.1
TBW8*095-L-SS	1/2	0.095	24.4	14.2	14.3
TBW12*120-L-SS	3/4	0.12	33.3	19.1	20.6
TBW16*134-L-SS	1	0.134	37.1	19.1	27
TBW10M*2.2-L-SS	10	2.2	18	9.7	11.1
TBW14M*2.5-L-SS	14	2.5	25.4	14.2	15.9
TBW16M*2.8-L-SS	16	2.8	26.2	14.2	17.5
TBW20M*3-L-SS	20	3	33.3	19.1	20.6
TBW22M*3-L-SS	22	3	35.3	19.1	23.8
TBW25M*3.5-L-SS	25	3.5	37.1	19.1	27

等径卡套三通

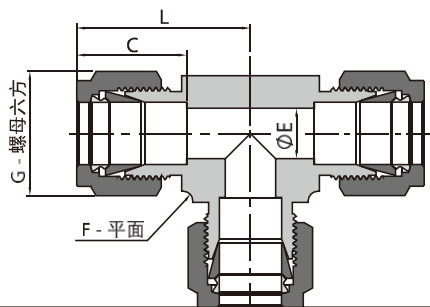

型号	接口类型和尺寸		尺寸 mm				
	卡套 in.		L	C	G	F	E
A1-T-SS	1/16		17.8	8.6	7.9	9.5	1.3
A2-T-SS	1/8		22.2	12.7	11.1	9.5	2.3
A3-T-SS	3/16		24.4	13.7	12.7	11.1	3
A4-T-SS	1/4		26.9	15.2	14.3	12.7	4.8
A5-T-SS	5/16		29.7	16.2	15.9	15.9	6.4
A6-T-SS	3/8		30.5	16.8	17.5	15.9	7.1
A8-T-SS	1/2		36.1	22.9	22.2	20.6	10.4
A10-T-SS	5/8		38.9	24.4	25.4	25.4	12.7
A12-T-SS	3/4		39.9	24.4	28.6	27	15.7
A14-T-SS	7/8		44.7	25.9	31.8	34.9	18.3
A16-T-SS	1		49	31.2	38.1	34.9	22.4
A18-T-SS	1 1/8		55.1	36.7	44.5	42.9	24.6
A20-T-SS	1 1/4		66.5	41.1	47.6	42.9	27.7
A24-T-SS	1 1/2		78	50	57.2	50.8	34

型号	接口类型和尺寸		尺寸 mm				
	卡套 mm		L	C	G	F	E
A2M-T-SS	2		22.3	12.9	12	9.5	1.7
A3M-T-SS	3		22.3	12.9	12	9.5	2.4
A4M-T-SS	4		25.4	13.7	12	12.7	2.4
A6M-T-SS	6		27	15.3	14	12.7	4.8
A8M-T-SS	8		29.9	16.2	16	15.9	6.4
A10M-T-SS	10		31.5	17.2	19	17.5	7.9
A12M-T-SS	12		36	22.8	22	20.6	9.5
A14M-T-SS	14		38.8	24.4	25	25.4	11.1
A15M-T-SS	15		38.8	24.4	25	25.4	11.9
A16M-T-SS	16		38.8	24.4	25	25.4	12.7
A18M-T-SS	18		39.8	24.4	30	27	15.1
A20M-T-SS	20		44.6	26	32	34.9	15.9
A22M-T-SS	22		44.6	26	32	34.9	18.3
A25M-T-SS	25		49.1	31.3	38	34.9	21.8
A28M-T-SS	28		64	36.6	46	42.9	21.8
A30M-T-SS	30		69.9	39.6	50	42.9	26.2
A32M-T-SS	32		72.3	42	50	42.9	28.6
A38M-T-SS	38		84	49.4	60	50.8	33.7

变径卡套三通

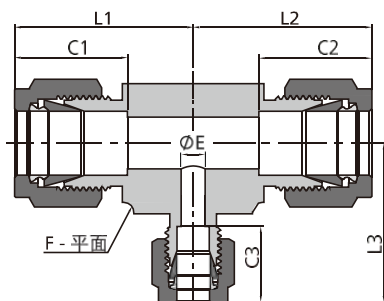

型号	接口类型和尺寸			尺寸 mm							
	端口1 卡套 in.	端口2 卡套 in.	端口3 卡套 in.	L1	L2	L3	C1	C2	C3	F	E
A4-A4-A2-T-SS	1/4	1/4	1/8	26.7	26.7	24.4	15.2	15.2	12.7	12.7	2.3
A6-A4-A4-T-SS	3/8	1/4	1/4	30.5	29	29	16.8	15.2	15.2	15.9	4.8
A6-A6-A4-T-SS	3/8	1/4	3/8	30.5	29	30.5	16.8	15.2	16.8	15.9	4.8
A6-A6-A4-T-SS	3/8	3/8	1/4	30.5	30.5	29	16.8	16.8	15.2	15.9	4.8
A8-A4-A4-T-SS	1/2	1/4	1/4	36.1	30.9	30.9	22.9	15.2	15.2	20.6	4.8
A8-A4-A8-T-SS	1/2	1/4	1/2	36.1	31.8	36.1	22.9	15.2	22.9	20.6	4.8
A8-A6-A6-T-SS	1/2	3/8	3/8	36.1	33.3	33.3	22.9	16.8	16.8	20.6	7.1
A8-A6-A8-T-SS	1/2	3/8	1/2	36.1	33.3	36.1	22.9	16.8	22.9	20.6	7.1
A8-A8-A4-T-SS	1/2	1/2	1/4	36.1	36.1	31.8	22.9	22.9	15.2	20.6	4.8
A8-A8-A6-T-SS	1/2	1/2	3/8	36.1	36.1	33.3	22.9	22.9	16.8	20.6	7.1
A10-A6-A6-T-SS	5/8	3/8	3/8	38.9	36.1	36.1	24.4	16.8	16.8	25.4	7.1
A10-A6-A8-T-SS	5/8	3/8	1/2	38.9	36.1	38.9	24.4	16.8	22.9	25.4	7.1
A10-A8-A6-T-SS	5/8	1/2	3/8	38.9	38.9	36.1	24.4	22.9	16.8	25.4	7.1
A10-A8-A8-T-SS	5/8	1/2	1/2	38.9	38.9	38.9	24.4	22.9	22.9	25.4	10.4
A10-A10-A6-T-SS	5/8	5/8	3/8	38.9	38.9	36.1	24.4	24.4	16.8	25.4	7.1
A10-A10-A8-T-SS	5/8	5/8	1/2	38.9	38.9	38.9	24.4	24.4	22.9	25.4	10.4
A12-A6-A6-T-SS	3/4	3/8	3/8	39.6	36.9	36.9	24.4	16.8	16.8	27	7.1
A12-A8-A6-T-SS	3/4	1/2	3/8	39.6	39.6	36.9	24.4	22.9	16.8	27	7.1
A12-A8-A8-T-SS	3/4	1/2	1/2	39.6	39.6	39.6	24.4	22.9	22.9	27	10.4
A12-A10-A6-T-SS	3/4	5/8	3/8	39.6	39.6	36.9	24.4	24.4	16.8	27	7.1
A12-A10-A8-T-SS	3/4	5/8	1/2	39.6	39.6	39.6	24.4	24.4	22.9	27	10.4
A12-A10-A10-T-SS	3/4	5/8	5/8	39.6	39.6	39.6	24.4	24.4	24.4	27	12.7
A12-A12-A4-T-SS	3/4	3/4	1/4	39.6	39.6	36.3	24.4	24.4	15.2	27	4.8

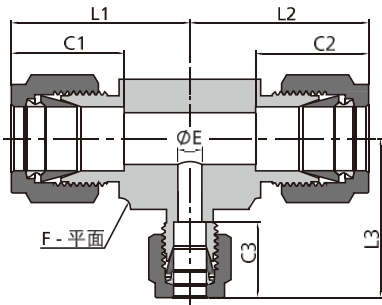

型号	接口类型和尺寸			尺寸 mm							
	端口1 卡套 in.	端口2 卡套 in.	端口3 卡套 in.	L1	L2	L3	C1	C2	C3	F	E
A12-A12-A6-T-SS	3/4	3/4	3/8	39.6	39.6	36.9	24.4	24.4	16.8	27	7.1
A12-A12-A8-T-SS	3/4	3/4	1/2	39.6	39.6	39.6	24.4	24.4	22.9	27	10.4
A12-A12-A10-T-SS	3/4	3/4	5/8	39.6	39.6	39.6	24.4	24.4	24.4	27	12.7
A14-A8-A12-T-SS	7/8	1/2	3/4	44.7	44.7	44.7	25.9	22.9	24.4	34.9	10.4
A14-A10-A6-T-SS	7/8	5/8	3/8	44.7	44.7	41.9	25.9	24.4	16.8	34.9	7.1
A14-A12-A6-T-SS	7/8	3/4	3/8	44.7	44.7	41.9	25.9	24.4	16.8	34.9	7.1
A14-A12-A8-T-SS	7/8	3/4	1/2	44.7	44.7	44.7	25.9	24.4	22.9	34.9	10.4
A14-A12-A12-T-SS	7/8	3/4	3/4	44.7	44.7	44.7	25.9	24.4	24.4	34.9	15.7
A14-A14-A4-T-SS	7/8	7/8	1/4	44.7	44.7	40.4	25.9	25.9	15.2	34.9	4.8
A14-A14-A6-T-SS	7/8	7/8	3/8	44.7	44.7	41.9	25.9	25.9	16.8	34.9	7.1
A16-A6-A6-T-SS	1	3/8	3/8	49.3	41.9	41.9	31.2	16.8	16.8	34.9	7.1
A16-A8-A4-T-SS	1	1/2	1/4	49.3	44.7	40.4	31.2	22.9	15.2	34.9	4.8
A16-A8-A6-T-SS	1	1/2	3/8	49.3	44.7	41.9	31.2	22.9	16.8	34.9	7.1
A16-A8-A8-T-SS	1	1/2	1/2	49.3	44.7	44.7	31.2	22.9	22.9	34.9	10.4
A16-A8-A16-T-SS	1	1/2	1	49.3	44.7	49.3	31.2	22.9	31.2	34.9	10.4
A16-A10-A6-T-SS	1	5/8	3/8	49.3	44.7	41.9	31.2	24.4	16.8	34.9	7.1
A16-A12-A6-T-SS	1	3/4	3/8	49.3	44.7	41.9	31.2	24.4	16.8	34.9	7.1
A16-A12-A8-T-SS	1	3/4	1/2	49.3	44.7	44.7	31.2	24.4	22.9	34.9	10.4
A16-A12-A10-T-SS	1	3/4	5/8	49.3	44.7	44.7	31.2	24.4	24.4	34.9	12.7
A16-A12-A16-T-SS	1	3/4	1	49.3	44.7	49.3	31.2	24.4	31.2	34.9	15.7
A16-A14-A4-T-SS	1	7/8	1/4	49.3	44.7	40.4	31.2	25.9	15.2	34.9	4.8
A16-A14-A6-T-SS	1	7/8	3/8	49.3	44.7	41.9	31.2	25.9	16.8	34.9	7.1
A16-A14-A8-T-SS	1	7/8	1/2	49.3	44.7	44.7	31.2	25.9	22.9	34.9	10.4
A16-A14-A12-T-SS	1	7/8	3/4	49.3	44.7	44.7	31.2	25.9	24.4	34.9	15.7
A16-A14-A14-T-SS	1	7/8	7/8	49.3	44.7	44.7	31.2	25.9	25.9	34.9	18.3
A16-A16-A4-T-SS	1	1	1/4	49.3	49.3	40.4	31.2	31.2	15.2	34.9	4.8
A16-A16-A6-T-SS	1	1	3/8	49.3	49.3	41.9	31.2	31.2	16.8	34.9	7.1
A16-A16-A8-T-SS	1	1	1/2	49.3	49.3	44.7	31.2	31.2	22.9	34.9	10.4
A16-A16-A10-T-SS	1	1	5/8	49.3	49.3	44.7	31.2	31.2	24.4	34.9	12.7
A16-A16-A12-T-SS	1	1	3/4	49.3	49.3	44.7	31.2	31.2	24.4	34.9	15.7
A16-A16-A14-T-SS	1	1	7/8	49.3	49.3	44.7	31.2	31.2	25.9	34.9	18.3
A20-A20-A16-T-SS	11/4	11/4	1	67.8	67.8	55.1	41.2	41.2	31.3	42.9	22.4
A24-A24-A16-T-SS	11/2	11/2	1	78.7	78.7	60	50	50	31.3	50.8	22.4
A3M-A3M-A6M-T-SS	3	3	6	24.7	24.7	27	12.9	12.9	15.3	12.7	2.4
A6M-A6M-A3M-T-SS	6	6	3	27	27	24.7	15.3	15.3	12.9	12.7	2.4
A6M-A6M-A8M-T-SS	6	6	8	28	28	28.8	15.3	15.3	16.2	14.3	4.8
A8M-A8M-A6M-T-SS	8	8	6	30	30	29	16.2	16.2	15.3	15.9	4.8
A8M-A8M-A12M-T-SS	8	8	12	35.2	35.2	36	16.2	16.2	22.8	20.6	6.4
A10M-A10M-A6M-T-SS	10	10	6	31.5	31.5	29.9	17.2	17.2	15.3	17.5	4.8
A10M-A10M-A8M-T-SS	10	10	8	31.5	31.5	30.7	17.2	17.2	16.2	17.5	6.4
A12M-A12M-A6M-T-SS	12	12	6	36	36	31.8	22.8	22.8	15.3	20.6	4.8
A12M-A12M-A8M-T-SS	12	12	8	36	36	32	22.8	22.8	16.2	20.6	6.4
A12M-A12M-A14M-T-SS	12	12	14	38	38	38	22.8	22.8	24.4	25.4	9.5
A12M-A12M-A18M-T-SS	12	12	18	39.8	39.8	39.8	22.8	22.8	24.4	27	9.5
A14M-A14M-A8M-T-SS	14	14	8	38	38	35.5	24.4	24.4	16.2	25.4	6.4
A14M-A14M-A10M-T-SS	14	14	10	38	38	36.7	24.4	24.4	17.2	25.4	7.9
A15M-A15M-A12M-T-SS	15	15	12	38.8	38.8	38.8	24.4	24.4	22.8	25.4	9.5
A16M-A8M-A16M-T-SS	16	8	16	38.8	35.5	38.8	24.4	16.2	24.4	25.4	6.4
A16M-A16M-A12M-T-SS	16	16	12	38.8	38.8	38.9	24.4	24.4	22.8	25.4	9.5
A18M-A18M-A8M-T-SS	18	18	8	39.8	39.8	39	24.4	24.4	16.2	27	6.4
A18M-A18M-A10M-T-SS	18	18	10	39.8	39.8	37.4	24.4	24.4	17.2	27	7.9
A18M-A18M-A12M-T-SS	18	18	12	39.8	39.8	39.8	24.4	24.4	22.8	27	9.5
A18M-A18M-A14M-T-SS	18	18	14	39.8	39.8	39.8	24.4	24.4	24.4	27	11.1
A20M-A20M-A14M-T-SS	20	20	14	44.6	44.6	44.6	26	26	24.4	34.9	11.1
A22M-A22M-A12M-T-SS	22	22	12	44.6	44.6	44.6	26	26	22.8	34.9	9.5
A25M-A25M-A12M-T-SS	25	25	12	49.1	49.1	44.7	31.3	31.3	22.8	34.9	9.5

支管外螺纹卡套三通

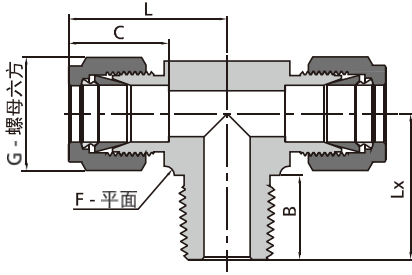

注: RC螺纹尺寸与NPT螺纹相同, 对应型号中只需把M变为MRC, 如SS-A6-A6-MRC-T-SS

型号	接口类型和尺寸		尺寸 mm						
	端口1, 2 卡套	端口3 MNPT	L	C	G	F	E	B	LX
A2-A2-M2-T-SS	1/8	1/8	23.6	12.7	11.1	11.1	2.3	9.7	17.8
A2-A2-M4-T-SS	1/8	1/4	24.6	12.7	11.1	12.7	2.3	14.2	23.4
A3-A3-M2-T-SS	3/16	1/8	24.4	13.7	12.7	11.1	3	9.7	17.8
A4-A4-M2-T-SS	1/4	1/8	26.9	15.2	14.3	12.7	4.8	9.7	18.8
A4-A4-M4-T-SS	1/4	1/4	26.9	15.2	14.3	12.7	4.8	14.2	23.4
A5-A5-M2-T-SS	5/16	1/8	29.7	16.3	15.9	15.9	4.8	9.7	20.8
A5-A5-M4-T-SS	5/16	1/4	29.7	16.3	15.9	15.9	6.4	14.2	25.7
A6-A6-M4-T-SS	3/8	1/4	30.5	16.8	17.5	15.9	7.1	14.2	25.4
A6-A6-M6-T-SS	3/8	3/8	33.3	16.8	17.5	20.6	7.1	14.2	28.2
A8-A8-M6-T-SS	1/2	3/8	36.1	22.9	22.2	20.6	9.7	14.2	28.2
A8-A8-M8-T-SS	1/2	1/2	36.1	22.9	22.2	20.6	10.4	19.1	33
A10-A10-M8-T-SS	5/8	1/2	38.9	24.4	25.4	25.4	11.9	19.1	35.8
A12-A12-M12-T-SS	3/4	3/4	39.9	24.4	28.6	27	15.7	19.1	36.8
A14-A14-M12-T-SS	7/8	3/4	47.8	25.9	31.8	34.9	15.7	19.1	47.5
A16-A16-M12-T-SS	1	3/4	49.3	31.2	38.1	34.9	15.7	19.1	47.5
A16-A16-M16-T-SS	1	1	49.3	31.2	38.1	34.9	22.4	23.9	46.7
A6M-A6M-M2-T-SS	6	1/8	27	15.3	14	12.7	4.8	9.7	18.8
A6M-A6M-M4-T-SS	6	1/4	27	15.3	14	12.7	4.8	14.2	23.4
A8M-A8M-M2-T-SS	8	1/8	29.9	16.2	16	15.9	4.8	9.7	20.8
A8M-A8M-M4-T-SS	8	1/4	29.9	16.2	16	15.9	6.4	14.2	25.4
A10M-A10M-M4-T-SS	10	1/4	33.5	17.2	19	20.6	7.1	14.2	28.2
A10M-A10M-M6-T-SS	10	3/8	33.5	17.2	19	20.6	7.9	14.2	28.2
A12M-A12M-M4-T-SS	12	1/4	36	22.8	22	20.6	7.1	14.2	28.2
A12M-A12M-M6-T-SS	12	3/8	36	22.8	22	20.6	9.5	14.2	28.2
A12M-A12M-M8-T-SS	12	1/2	36	22.8	22	20.6	9.5	19.1	33
A16M-A16M-M8-T-SS	16	1/2	38.8	24.4	25	25.4	11.9	19.1	35.8

主管外螺纹卡套三通

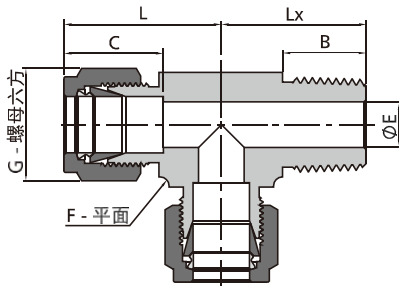

型号	接口类型和尺寸		尺寸 mm						
	端口1, 3 卡套 in.	端口2 外螺纹 in.	L	C	G	F	E	B	LX
A2-M2-A2-T-SS	1/8	1/8	23.6	12.7	11.1	11.1	2.3	9.7	17.8
A2-M4-A2-T-SS	1/8	1/4	24.6	12.7	11.1	12.7	2.3	14.2	23.4
A3-M2-A3-T-SS	3/16	1/8	24.4	13.7	12.7	11.1	3	9.7	17.8
A4-M2-A4-T-SS	1/4	1/8	26.9	15.2	14.3	12.7	4.8	9.7	18.8
A4-M4-A4-T-SS	1/4	1/4	26.9	15.2	14.3	12.7	4.8	14.2	23.4
A5-M2-A5-T-SS	5/16	1/8	29.7	16.3	15.9	15.9	4.8	9.7	20.8
A5-M4-A5-T-SS	5/16	1/4	29.7	16.3	15.9	15.9	6.4	14.2	25.7
A6-M4-A6-T-SS	3/8	1/4	30.5	16.8	17.5	15.9	7.1	14.2	25.4
A6-M6-A6-T-SS	3/8	3/8	33.3	16.8	17.5	20.6	7.1	14.2	28.2
A8-M6-A8-T-SS	1/2	3/8	36.1	22.9	22.2	20.6	9.7	14.2	28.2
A8-M8-A8-T-SS	1/2	1/2	36.1	22.9	22.2	20.6	10.4	19.1	33
A10-M8-A10-T-SS	5/8	1/2	38.1	24.4	25.4	23.8	11.9	19.1	35.8
A12-M12-A12-T-SS	3/4	3/4	39.9	24.4	28.6	27	15.7	19.1	36.8
A14-M12-A14-T-SS	7/8	3/4	47.8	25.9	31.8	34.9	15.7	19.1	47.5
A16-M12-A16-T-SS	1	3/4	49.3	31.2	38.1	34.9	15.7	19.1	47.5
A16-M16-A16-T-SS	1	1	49.3	31.2	38.1	34.9	22.4	23.9	46.7
A6M-M2-A6M-T-SS	6	1/8	27	15.3	14	12.7	4.8	9.7	18
A6M-M4-A6M-T-SS	6	1/4	27	15.3	14	12.7	4.8	14.2	23.4
A8M-M2-A8M-T-SS	8	1/8	29.9	16.2	16	15.9	4.8	9.7	20.8
A8M-M4-A8M-T-SS	8	1/4	29.9	16.2	16	15.9	6.4	14.2	25.4
A10M-M4-A10M-T-SS	10	1/4	33.5	17.2	19	20.6	7.1	14.2	28.2
A10M-M8-A10M-T-SS	10	1/2	33.5	17.2	19	20.6	7.9	19.1	33
A12M-M4-A12M-T-SS	12	1/4	36	22.8	22	20.6	7.1	14.2	28.2
A12M-M6-A12M-T-SS	12	3/8	36	22.8	22	20.6	9.5	14.2	28.2
A12M-M8-A12M-T-SS	12	1/2	36	22.8	22	20.6	9.5	19.1	33
A16M-M8-A16M-T-SS	16	1/2	38	24.4	25	23.8	11.9	19.1	35

支管可调SAE/MS外螺纹卡套三通

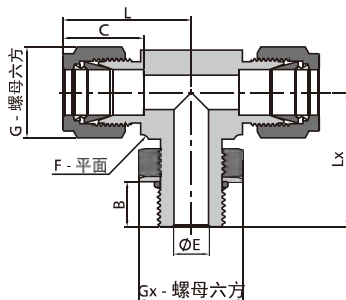

型号	接口类型和尺寸		尺寸 mm							
	端口1, 2 卡套 in.	端口3 可调SAE/MS直螺纹 in.	L	B	C	E	G	F	Lx	GX
A4-A4-MUNF7/16-20-TP-SS	1/4	7/16-20	28.5	9.9	15.2	4.8	14.3	12.7	27	14.3
A6-A6-MUNF9/16-18-TP-SS	3/8	9/16-18	32	11.2	16.8	7.1	17.5	15.9	32.3	17.5
A8-A8-MUNF3/4-16-TP-SS	1/2	3/4-16	37.6	12.7	22.9	10.4	22.2	20.6	37.8	22.2
A12-A12-MUNF11/16-12-TP-SS	3/4	11/16-12	41.4	16.8	24.4	15.7	28.6	27	48.8	31.8
A16-A16-MUNF15/16-12-TP-SS	1	15/16-12	50.5	16.8	31.2	22.4	38.1	34.9	53.6	38.1
A20-A20-MUNF15/8-12-TP-SS	1 1/4	15/8-12	67.8	16.8	41.1	27.7	47.6	42.9	58.2	47.6
A24-A24-MUNF17/8-12-TP-SS	1 1/2	17/8-12	78	16.8	50	34	57.2	50.8	60.5	54

主管可调SAE/MS外螺纹卡套三通

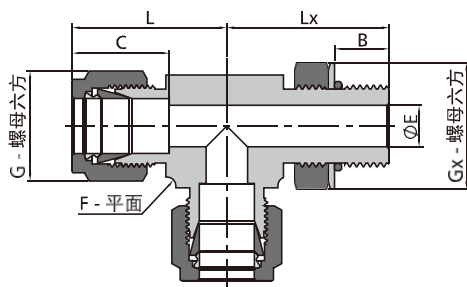

型号	接口类型和尺寸		尺寸 mm							
	端口1, 3 卡套 mm	端口2 可调SAE/MS直螺纹 in.	L	B	C	E	G	F	Lx	GX
A4-MUNF7/16-20-A4-TP-SS	1/4	7/16-20	28.5	9.9	15.2	4.8	14.3	12.7	27	14.3
A6-MUNF9/16-18-A6-TP-SS	3/8	9/16-18	32	11.2	16.8	7.1	17.5	15.9	32.3	17.5
A8-MUNF3/4-16-A8-TP-SS	1/2	3/4-16	37.6	12.7	22.9	10.4	22.2	20.6	37.8	22.2
A12-MUNF11/16-12-A12-TP-SS	3/4	11/16-12	41.4	16.8	24.4	15.7	31.8	27	48.8	31.8
A16-MUNF15/16-12-A16-TP-SS	1	15/16-12	50.5	16.8	31.2	22.4	38.1	34.9	53.6	38.1
A20-MUNF15/8-12-A20-TP-SS	1 1/4	15/8-12	67.8	16.8	41.1	27.7	47.6	42.9	58.2	47.6
A24-MUNF17/8-12-A24-TP-SS	1 1/2	17/8-12	78	16.8	50	34	57.2	50.8	60.5	54

支管可调ISO平行外螺纹卡套三通

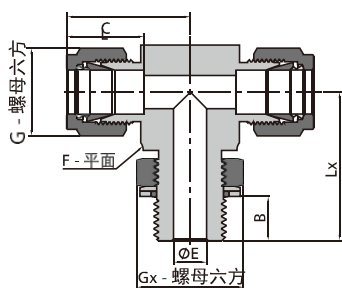

型号	接口类型和尺寸		尺寸 mm							
	端口1, 2 卡套 in.	端口3 可调ISO直螺纹 in.	L	B	C	E	G	F	Lx	GX
A4-A4-MG2-TP-SS	1/4	1/8	26.9	6.6	15.2	4.1	14.3	12.7	26.4	14.3
A4-A4-MG4-TP-SS	1/4	1/4	29	9	15.2	4.8	14.3	15.9	32.3	19.1
A6-A6-MG4-TP-SS	3/8	1/4	30.5	9	16.8	5.8	17.5	15.9	32.3	19.1
A8-A8-MG6-TP-SS	1/2	3/8	36.1	9.4	22.9	7.9	22.2	20.6	37.1	22.2
A8-A8-MG8-TP-SS	1/2	1/2	38.1	13	22.9	10.4	22.2	23.8	43.4	27
A10-A10-MG8-TP-SS	5/8	1/2	38.1	13	24.4	11.9	25.4	23.8	43.4	27
A12-A12-MG8-TP-SS	3/4	1/2	39.9	13	24.4	11.9	28.6	27	45.2	27
A12-A12-MG12-TP-SS	3/4	3/4	39.9	13	24.4	15.7	28.6	27	48.8	34.9
A16-A16-MG16-TP-SS	1	1	49	13.2	31.2	19.8	38.1	34.9	53.6	41.3

型号	接口类型和尺寸		尺寸 mm							
	端口1, 2 卡套 mm	端口3 可调ISO直螺纹 in.	L	B	C	E	G	F	Lx	GX
A6M-A6M-MG2-TP-SS	6	1/8	27	6.6	15.3	4	14	12.7	26.4	14.3
A6M-A6M-MG4-TP-SS	6	1/4	29	9	15.3	4.8	14	15.9	32.2	19.1
A8M-A8M-MG2-TP-SS	8	1/8	28.8	6.6	16.2	4	16	14.3	27.5	14.3
A8M-A8M-MG4-TP-SS	8	1/4	29.9	9	16.2	5.9	16	15.9	32.2	19.1
A10M-A10M-MG4-TP-SS	10	1/4	33.5	9	17.2	5.9	19	20.6	35.1	19.1
A12M-A12M-MG6-TP-SS	12	3/8	36	9.4	22.8	7.9	22	20.6	37.1	22.2
A12M-A12M-MG8-TP-SS	12	1/2	38	13	22.8	9.5	22	23.8	43.5	27

主管可调ISO平行外螺纹卡套三通接头

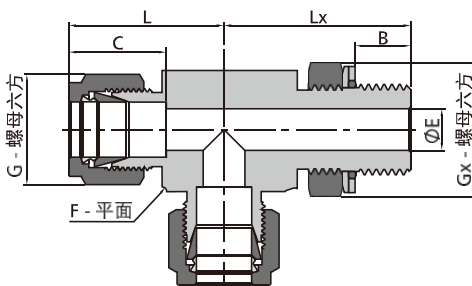

型号	接口类型和尺寸		尺寸 mm							
	端口1, 3 卡套 in.	端口2 可调ISO直螺纹 in.	L	B	C	E	G	F	Lx	GX
A4-MG2-A4-TP-SS	1/4	1/8	26.9	6.6	15.2	4.1	14.3	12.7	26.4	14.3
A4-MG4-A4-TP-SS	1/4	1/4	29	9	15.2	4.8	14.3	15.9	32.3	19.1
A6-MG4-A6-TP-SS	3/8	1/4	30.5	9	16.8	5.8	17.5	15.9	32.3	19.1
A8-MG6-A8-TP-SS	1/2	3/8	36.1	9.4	22.9	7.9	22.2	20.6	37.1	22.2
A8-MG8-A8-TP-SS	1/2	1/2	38.1	13	22.9	10.4	22.2	23.8	43.4	27
A10-MG8-A10-TP-SS	5/8	1/2	38.1	13	24.4	11.9	25.4	23.8	43.4	27
A12-MG8-A12-TP-SS	3/4	1/2	39.9	13	24.4	11.9	28.6	27	45.2	27
A12-MG12-A12-TP-SS	3/4	3/4	39.9	13	24.4	15.7	28.6	27	48.8	34.9
A16-MG16-A16-TP-SS	1	1	49	13.2	31.2	19.8	38.1	34.9	53.6	41.3

型号	接口类型和尺寸		尺寸 mm							
	端口1, 3 卡套 mm	端口2 可调ISO直螺纹 in.	L	B	C	E	G	F	Lx	GX
A6M-MG2-A6M-TP-SS	6	1/8	27	6.6	15.3	4	14	12.7	26.4	14.3
A6M-MG4-A6M-TP-SS	6	1/4	29	9	15.3	4.8	14	15.9	32.2	19.1
A8M-MG2-A8M-TP-SS	8	1/8	28.8	6.6	16.2	4	16	14.3	27.5	14.3
A8M-MG4-A8M-TP-SS	8	1/4	29.9	9	16.2	5.9	16	15.9	32.2	19.1
A10M-MG4-A10M-TP-SS	10	1/4	33.5	9	17.2	5.9	19	20.6	35.1	19.1
A12M-MG6-A12M-TP-SS	12	3/8	36	9.4	22.8	7.9	22	20.6	37.1	22.2
A12M-MG8-A12M-TP-SS	12	1/2	38	13	22.8	9.5	22	23.8	43.5	27

支管NPT内螺纹卡套三通

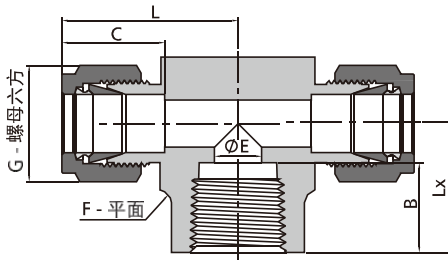

型号	接口类型和尺寸		尺寸 mm						
	端口1, 2 卡套 in.	端口3 FNPT in.	L	C	G	F	E	B	LX
A2-A2-F2-T-SS	1/8	1/8	24.6	12.7	11.1	12.7	2.3	10.4	19.1
A3-A3-F2-T-SS	3/16	1/8	25.7	13.7	12.7	12.7	3	10.4	19.1
A4-A4-F2-T-SS	1/4	1/8	26.9	15.2	14.3	12.7	4.8	10.4	19.1
A4-A4-F4-T-SS	1/4	1/4	29.7	15.2	14.3	17.5	4.8	15	22.4
A5-A5-F2-T-SS	5/16	1/8	29.7	16.2	15.9	15.9	6.4	10.4	19.1
A6-A6-F4-T-SS	3/8	1/4	31.2	16.8	17.5	17.5	7.1	15	22.4
A6-A6-F6-T-SS	3/8	3/8	33.3	16.8	17.5	20.6	7.1	15	22.4
A6-A6-F8-T-SS	3/8	1/2	36.1	16.8	17.5	25.4	7.1	19.8	28.4
A8-A8-F4-T-SS	1/2	1/4	36.1	22.9	22.2	20.6	10.4	15	22.4
A8-A8-F6-T-SS	1/2	3/8	36.1	22.9	22.2	20.6	10.4	15	22.4
A8-A8-F8-T-SS	1/2	1/2	38.9	22.9	22.2	25.4	10.4	19.8	28.4
A10-A10-F8-T-SS	5/8	1/2	38.9	24.4	25.4	25.4	12.7	19.8	28.4
A12-A12-F12-T-SS	3/4	3/4	44.7	24.4	28.6	34.9	15.7	20.6	31.8
A14-A14-F12-T-SS	7/8	3/4	44.7	25.9	31.8	34.9	18.3	20.6	31.8
A16-A16-F12-T-SS	1	3/4	49	31.2	38.1	34.9	22.4	20.6	31.8
A16-A16-F16-T-SS	1	1	53.6	31.2	38.1	42.9	22.4	25.4	38.1
A6M-A6M-F2-T-SS	6	1/8	27	15.3	14	12.7	4.8	10.4	19
A6M-A6M-F4-T-SS	6	1/4	29.8	15.3	14	17.5	4.8	15	22.4
A8M-A8M-F2-T-SS	8	1/8	29.9	16.2	16	15.9	6.4	10.4	19
A8M-A8M-F4-T-SS	8	1/4	30.6	16.2	16	17.5	6.4	15	22.4
A10M-A10M-F4-T-SS	10	1/4	33.5	17.2	19	20.6	7.9	15	22.4
A12M-A12M-F2-T-SS	12	1/8	36	22.8	22	20.6	6.4	10.4	22.3
A12M-A12M-F4-T-SS	12	1/4	36	22.8	22	20.6	9.5	15	22.4
A12M-A12M-F6-T-SS	12	3/8	36	22.8	22	20.6	9.5	15	22.4
A12M-A12M-F8-T-SS	12	1/2	38.8	22.8	22	25.4	9.5	19.8	28.5
A16M-A16M-F8-T-SS	16	1/2	38.8	24.4	25	25.4	12.7	19.8	28.4

主管NPT内螺纹卡套三通

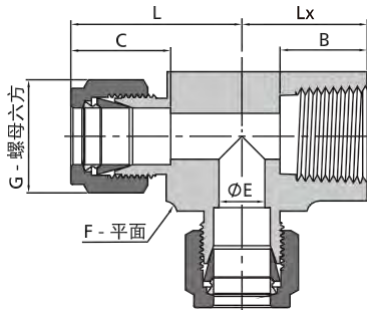

型号	接口类型和尺寸		尺寸 mm						
	端口1, 3 卡套 in.	端口2 FNPT in.	L	C	G	F	E	B	LX
A2-F2-A2-T-SS	1/8	1/8	24.6	12.7	11.1	12.7	2.3	10.4	19.1
A3-F2-A3-T-SS	3/16	1/8	25.7	13.7	12.7	12.7	3	10.4	19.1
A4-F2-A4-T-SS	1/4	1/8	26.9	15.2	14.3	12.7	4.8	10.4	19.1
A4-F4-A4-T-SS	1/4	1/4	29.7	15.2	14.3	17.5	4.8	15	22.4
A5-F2-A5-T-SS	5/16	1/8	29.7	16.2	15.9	15.9	6.4	10.4	19.1
A6-F4-A6-T-SS	3/8	1/4	31.2	16.8	17.5	17.5	7.1	15	22.4
A8-F4-A8-T-SS	1/2	1/4	36.1	22.9	22.2	20.6	10.4	15	22.4
A8-F6-A8-T-SS	1/2	3/8	36.1	22.9	22.2	20.6	10.4	15	22.4
A8-F8-A8-T-SS	1/2	1/2	39.9	22.9	22.2	27	10.4	19.8	28.4
A10-F8-A10-T-SS	5/8	1/2	39.9	24.4	25.4	27	12.7	19.8	28.4
A12-F12-A12-T-SS	3/4	3/4	44.7	24.4	28.6	34.9	15.7	20.6	31.8
A14-F8-A14-T-SS	7/8	1/2	44.7	25.9	31.8	34.9	15.7	19.8	28.4
A14-F12-A14-T-SS	7/8	3/4	44.7	25.9	31.8	34.9	18.3	20.6	31.8
A16-F12-A16-T-SS	1	3/4	49	31.2	38.1	34.9	22.4	20.6	31.8
A16-F16-A16-T-SS	1	1	53.6	31.2	38.1	42.9	22.4	25.4	38.1
A6M-F2-A6M-T-SS	6	1/8	27	15.3	14	12.7	4.8	10.4	19
A6M-F4-A6M-T-SS	6	1/4	29.8	15.3	14	17.5	4.8	15	22.4
A8M-F2-A8M-T-SS	8	1/8	29.9	16.2	16	15.9	6.4	10.4	19
A8M-F4-A8M-T-SS	8	1/4	30.6	16.2	16	17.5	6.4	15	22.4
A10M-F4-A10M-T-SS	10	1/4	33.5	17.2	19	20.6	7.9	15	22.4
A12M-F4-A12M-T-SS	12	1/4	36	22.8	22	20.6	9.5	15	22.4
A12M-F6-A12M-T-SS	12	3/8	36	22.8	22	20.6	9.5	15	23.1
A12M-F8-A12M-T-SS	12	1/2	38.8	22.8	22	25.4	9.5	19.8	28.5
A16M-F8-A16M-T-SS	16	1/2	39.8	24.4	25	27	12.7	19.8	28.4

NPT外螺纹三通

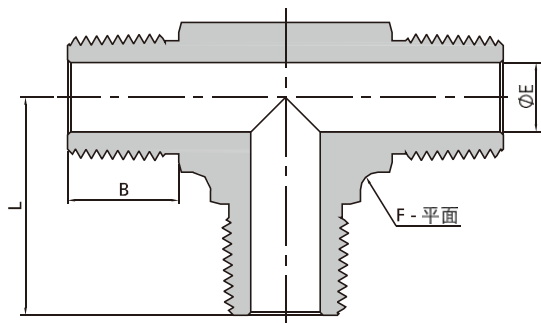

型号	接口类型和尺寸		尺寸 mm			
	端口1 MNPT in.		L	F	B	E
M1-T-SS	1/16		17	9.5	9.7	3
M2-T-SS	1/8		22.4	11.1	9.7	4.8
M4-T-SS	1/4		26.7	12.7	14.2	7.1
M6-T-SS	3/8		29.7	17.5	14.2	9.6
M8-T-SS	1/2		36.8	20.6	19.1	11.9
M12-T-SS	3/4		42.4	27	19.1	15.7
M16-T-SS	1		49.3	34.9	23.9	22.4

NPT内螺纹三通

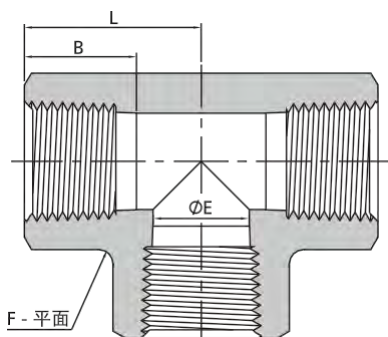

型号	接口类型和尺寸		尺寸 mm			
	端口 FNPT in.		L	F	B	E
F1-T-SS	1/16		21.8	11.1	4.8	9.9
F2-T-SS	1/8		26.4	12.7	8.6	10.4
F4-T-SS	1/4		29.7	17.5	11.4	15
F6-T-SS	3/8		36.1	20.6	15	15
F8-T-SS	1/2		39.6	25.4	18.5	19.8
F12-T-SS	3/4		48.8	31.8	23.9	20.6
F16-T-SS	1		48.5	42.9	29.7	25.4
F20-T-SS	1 1/4		59.8	50.8	37.2	25.4
F24-T-SS	1 1/2		65	63.5	43.3	27.7

支管NPT内螺纹三通

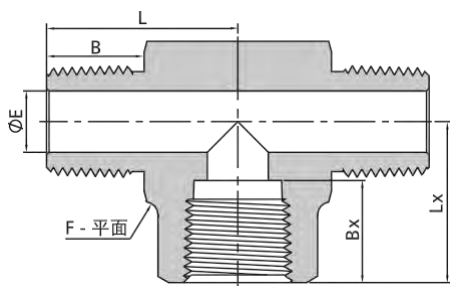

型号	接口类型和尺寸		尺寸 mm					
	端口1,2 MNPT in.	端口3 FNPT in.	L	F	E	B	Lx	Bx
M1-M1-F1-T-SS	1/16	1/16	18.3	11.1	3	9.7	21.8	9.9
M2-M2-F2-T-SS	1/8	1/8	22.1	12.7	4.8	9.7	26.4	10.4
M4-M4-F4-T-SS	1/4	1/4	29.7	17.5	7.1	14.2	29.7	15
M6-M6-F6-T-SS	3/8	3/8	32	20.6	9.6	14.2	36.1	15
M8-M8-F8-T-SS	1/2	1/2	39.6	25.4	11.9	19.1	39.6	19.8
M12-M12-F12-T-SS	3/4	3/4	42.4	31.8	15.7	19.1	48.8	20.6
M16-M16-F16-T-SS	1	1	49.3	42.9	22.4	23.9	48.5	25.4

卡套管等径对焊三通

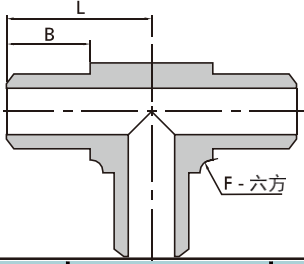

型号	接口类型和尺寸		尺寸 mm		
	端口1 Tube管对焊		L	B	F
	外径 in.	壁厚 in.			
TBW4*065-T-SS	1/4	0.065	16.3	9.7	9.5
TBW6*095-T-SS	3/8	0.095	18	9.7	11.1
TBW8*095-T-SS	1/2	0.095	24.4	14.2	14.3
TBW12*120-T-SS	3/4	0.120	33.3	19.1	20.6
TBW16*134-T-SS	1	0.134	37.1	19.1	27

型号	接口类型和尺寸		尺寸 mm		
	端口1 Tube管对焊		L	B	F
	外径 mm	壁厚 mm			
TBW6M*1.8-T-SS	6	1.8	16.3	9.7	9.5
TBW8M*1.8-T-SS	8	1.8	16.3	9.7	9.5
TBW10M*2.2-T-SS	10	2.2	18	9.7	11.1
TBW12M*2.2-T-SS	12	2.2	24.4	14.2	14.3
TBW14M*2.5-T-SS	14	2.5	25.4	14.2	15.9
TBW16M*2.8-T-SS	16	2.8	26.2	14.2	17.5
TBW20M*3-T-SS	20	3	33.3	19.1	20.6
TBW22M*3-T-SS	22	3	35.3	19.1	23.8
TBW25M*3.5-T-SS	25	3.5	37.1	19.1	27
TBW32M*4.5-T-SS	32	4.5	49.3	23.9	34.9

卡套管等径承插焊三通

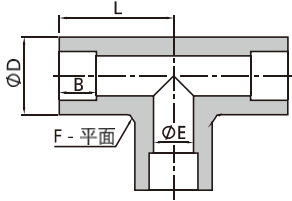

型号	接口类型和尺寸	尺寸 mm				
	Tube管插焊 in.	L	D	B	F	E
TSW2-T-SS	1/8	15	10	2.5	11.1	2.3
TSW4-T-SS	1/4	21.8	12.8	7.1	11.1	4.8
TSW6-T-SS	3/8	26.4	16.5	7.9	14.3	7.1
TSW8-T-SS	1/2	29.7	20.2	9.7	17.5	10.4
TSW10-T-SS	5/8	36.1	23.8	10.4	20.6	12.7
TSW12-T-SS	3/4	39.6	29.3	11.2	25.4	16
TSW16-T-SS	1	48.8	36.7	15.7	31.8	22.4

型号	接口类型和尺寸	尺寸 mm				
	Tube管插焊 mm	L	D	B	F	E
TSW8M-T-SS	8	19.8	14.7	7.9	12.7	6.4
TSW10M-T-SS	10	24.6	16.5	7.9	14.3	7.4
TSW12M-T-SS	12	29.7	20.2	9.7	17.5	9.5
TSW14M-T-SS	14	31.7	23.8	10	20.6	10.4
TSW16M-T-SS	16	36	23.8	10.4	20.6	12.7
TSW20M-T-SS	20	39.6	29.3	11.2	25.4	17
TSW22M-T-SS	22	41.3	31.2	13.5	27	19
TSW25M-T-SS	25	48.8	36.7	15.7	31.8	22

等径卡套四通

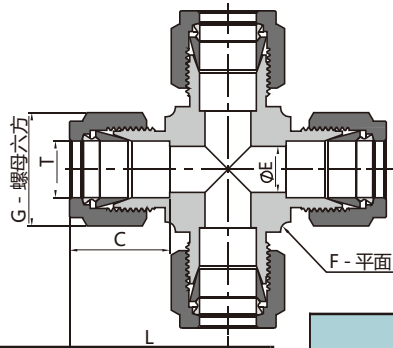

型号	接口类型 和尺寸 卡套 in.	尺寸 mm				
		L	C	G	F	E
A2-C-SS	1/8	22.4	12.7	11.1	9.5	2.3
A3-C-SS	3/16	24.4	13.7	12.7	11.1	3
A4-C-SS	1/4	26.9	15.2	14.3	12.7	4.8
A5-C-SS	5/16	29.7	16.2	15.9	15.9	6.4
A6-C-SS	3/8	30.5	16.8	17.5	15.9	7.1
A8-C-SS	1/2	36.1	22.9	22.2	20.6	10.4
A10-C-SS	5/8	38.8	24.4	25.4	25.4	12.7
A12-C-SS	3/4	39.9	24.4	28.6	27	15.7
A14-C-SS	7/8	44.7	25.9	31.8	34.9	18.3
A16-C-SS	1	49	31.2	38.1	34.9	22.4

型号	接口类型 和尺寸 卡套 mm	尺寸 mm				
		L	C	G	F	E
A3M-C-SS	3	22.3	12.9	12	9.52	0.4
A4M-C-SS	4	25.4	13.7	12	12.7	2.4
A6M-C-SS	6	27	15.3	14	12.7	4.8
A8M-C-SS	8	29.9	16.2	16	15.9	6.4
A10M-C-SS	10	33.5	17.2	19	20.6	7.9
A12M-C-SS	12	36	22.8	22	20.6	9.5
A16M-C-SS	16	37	24.4	25	23.8	12.7
A18M-C-SS	18	38.3	24.4	30	27	15.1
A20M-C-SS	20	44.6	26	32	34.9	15.9
A22M-C-SS	22	44.7	26	32	34.9	18.3
A25M-C-SS	25	49.2	31.3	38	34.9	21.8

NPT内螺纹四通

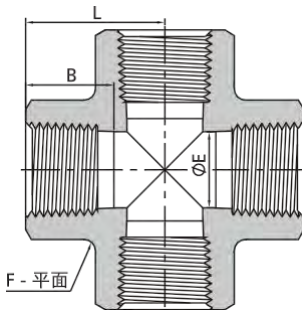

型号	接口类型和尺寸 端口 FNPT in.	尺寸 mm			
		L	F	B	E
F1-C-SS	1/16	21.8	11.1	4.8	9.9
F2-C-SS	1/8	26.4	12.7	8.6	10.4
F4-C-SS	1/4	29.7	17.5	11.4	15
F6-C-SS	3/8	36.1	20.6	15	15
F8-C-SS	1/2	39.6	25.4	18.5	19.8
F12-C-SS	3/4	48.8	31.8	23.9	20.6
F16-C-SS	1	48.5	42.9	29.7	25.4

卡套管对焊四通

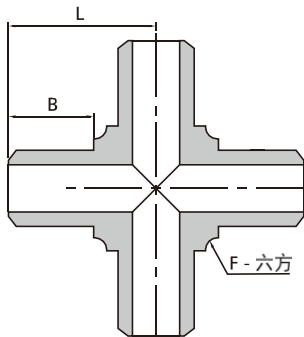

型号	接口类型和尺寸		尺寸 mm		
	端口1 Tube管对焊		L	B	F
	外径 in.	壁厚 in.			
TBW4*065-C-SS	1/4	0.065	16.3	9.7	9.5
TBW6*095-C-SS	3/8	0.095	18	9.7	11.1
TBW8*095-C-SS	1/2	0.095	24.4	14.2	14.3
TBW12*120-C-SS	3/4	0.120	33.3	19.1	20.6
TBW16*134-C-SS	1	0.134	41.3	19.1	31.8

型号	接口类型和尺寸		尺寸 mm		
	端口1 Tube管对焊		L	B	F
	外径 mm	壁厚 mm			
TBW6M*1.8-C-SS	6	1.8	16.3	9.7	9.5
TBW8M*1.8-C-SS	8	1.8	16.3	9.7	9.5
TBW10M*2.2-C-SS	10	2.2	18	9.7	11.1

卡套管承插焊四通

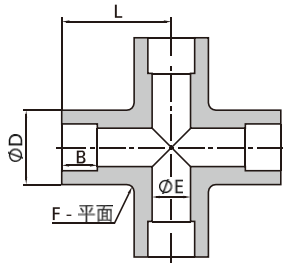

型号	接口类型 和尺寸	尺寸 mm				
	Tube管 插焊	L	D	B	F	E
TSW2-C-SS	1/8	15	11	2.5	11.1	2.3
TSW4-C-SS	1/4	21.8	12.8	7.1	11.1	4.8
TSW6-C-SS	3/8	26.4	14.7	7.9	12.7	7.1
TSW8-C-SS	1/2	29.7	20.2	9.7	17.5	10.4
TSW10-C-SS	5/8	36.1	23.8	10.4	20.6	12.7
TSW12-C-SS	3/4	39.6	29.3	11.2	25.4	16
TSW16-C-SS	1	48.8	36.7	15.7	31.8	22.4
TSW8M-C-SS	8	19.8	14.7	7.9	12.7	6.4
TSW10M-C-SS	10	24.6	16.5	7.9	14.3	7.1
TSW12M-C-SS	12	29.7	20.2	9.7	17.5	9.5
TSW14M-C-SS	14	31.7	23.8	10	20.6	10.4
TSW16M-C-SS	16	36	23.8	10.4	20.6	12.7
TSW20M-C-SS	20	39.6	29.3	11.2	25.4	17
TSW22M-C-SS	22	42.2	31.2	13.5	27	19
TSW25M-C-SS	25	48.8	36.7	15.7	31.8	22

选型说明

A6M

端口1/端口2/端口3/端口4

端口形式	
SET	卡套组件
N	卡套螺母
AC	卡套管帽
AP	卡套堵头
FC	内螺纹管帽
MP	外螺纹堵头
MPG	G外螺纹堵头
MP()	外螺纹内六角堵头
MPUNF/_/_	SAE/MS外螺纹堵头
MP (UNF) _/_	SAE/MS外螺纹内六角堵头
MPM_*	公制外螺纹堵头
A	双卡套
TA	卡套管
BA	穿板双卡套
IN	软管插头
M	NPT外螺纹
F	NPT内螺纹
MO	NPT外螺纹 (带O型圈)
MAN	37°坡口外螺纹
MGA	ISO平行外螺纹 (根部复合垫片密封)
MGB	ISO平行外螺纹 (根部金属垫片或O型圈密封)
MM_*	公制外螺纹
FM_*	公制内螺纹
MOM_*	公制外螺纹 (根部O型圈密封)
MG	G外螺纹
FG	G内螺纹
MUNF/_/_	SAE/MS外螺纹
MOUNF/_/_	SAE/MS外螺纹(根部扣压O型圈密封)
TBW	卡套管对焊
PBW	公称管对焊
TSW	卡套管承插焊
PSW	公称管承插焊
FGP	内螺纹钢瓶接口

- M4

端口1/端口2/端口3/端口4

端口尺寸			
公制		英制	
2M	2mm	1	1/16 in.
3M	3mm	2	1/8 in.
4M	4mm	3	3/16 in.
6M	6mm	4	1/4 in.
8M	8mm	5	5/16 in.
10M	10mm	6	3/8 in.
12M	12mm	8	1/2 in.
14M	14mm	10	5/8 in.
16M	16mm	12	3/4 in.
18M	18mm	14	7/8 in.
20M	20mm	16	1 in.
22M	22mm	18	1 1/8 in.
24M	24mm	20	1 1/4 in.
25M	25mm	24	1 1/2 in.
28M	28mm	32	2 in.
30M	30mm		
32M	32mm		
38M	38mm		
50M	50mm		
	M10*1		
	M12*1.5		
	M14*1.5		
	M16*1.5		
	M18*1.5		
	M20*1.5		
	M22*1.5		

- U

接头形式	
	单头 (堵头、管帽)
U	直通接头
UA	活接头
L	90°弯通接头
L1	45°弯通接头
LP	可定位弯通接头
T	三通接头
TP	可定位三通接头
C	四通接头

- SS

本体材质	
SS	316不锈钢
316L	316L不锈钢
304	304不锈钢
321	321不锈钢
91	F91合金
92	F92合金
2205	双相钢2205
2507	双相钢2507
TI	钛
A20	Alloy 20合金
M400	蒙乃尔 400合金
600	INCONEL600合金
C276	哈氏合金C-276
BR	黄铜
CS	碳钢
PTFE	聚四氟乙烯

端口顺序示意：

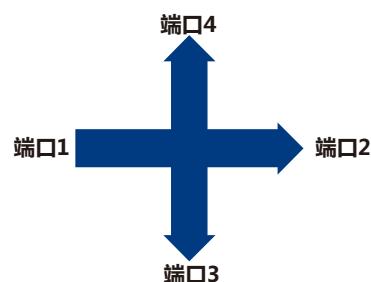

端口1, 2, 3, 4应该按照以下规则来描述型号：

1. 卡套 - 卡套管 - NPT 螺纹 - RC 锥螺纹 - 公制螺纹 - ISO 平行螺纹 - SAE/MS直螺纹 - 37°扩口 - Tube管对焊 - Tube管插焊，先外螺纹后内螺纹，先公制后英制。
2. 如果所有接头的类型和尺寸都相同，只需描述P1端口。
3. 对于穿板接头，先描述穿板所在的一侧。

注：选型说明只为产品选型提供参考，不能任意组合，标准型号请参考型号尺寸表，如不能满足您的技术要求，请咨询Easylight销售代表。

注：

1. RC和NPT螺纹外形尺寸一致，选型时只需把型号中的M变为MRC或F变为FRC，详细参数请参考型号尺寸表。

2. 公制螺纹在型号中需体现完整，例如A6M-MM20*1.5-U-SS，详细参数请参考型号尺寸表。

3. SAE/MS螺纹在型号中需体现完整，例如A6M-MUNF9/16-18-U-SS，详细参数请参考型号尺寸表。

4. Tube管对焊在型号中需体现壁厚，例如F4-TBW4*0.065-U-SS。

5. Pipe管对焊、Pipe管插焊需要提供具体Pipe管的真实外径和内径（或壁厚）尺寸，具体型号请咨询Easylight销售代表。